

INSTALLATION INSTRUCTIONS

PACKAGE HEAT PUMPS FEATURING EARTH-FRIENDLY R-410A REFRIGERANT



RQPM 14 SEER SERIES – (2 - 5 TONS)

RQNM 13 SEER SERIES – (2 - 5 TONS)



RECOGNIZE THIS SYMBOL AS AN INDICATION OF IMPORTANT SAFETY INFORMATION!

▲ WARNING

THESE INSTRUCTIONS ARE INTENDED AS AN AID TO QUALIFIED, LICENSED SERVICE PERSONNEL FOR PROPER INSTALLATION, ADJUSTMENT AND OPERATION OF THIS UNIT. READ THESE INSTRUCTIONS THOROUGHLY BEFORE ATTEMPTING INSTALLATION OR OPERATION. FAILURE TO FOLLOW THESE INSTRUCTIONS MAY RESULT IN IMPROPER INSTALLATION, ADJUSTMENT, SERVICE OR MAINTENANCE POSSIBLY RESULTING IN FIRE, ELECTRICAL SHOCK, PROPERTY DAMAGE, PERSONAL INJURY OR DEATH.

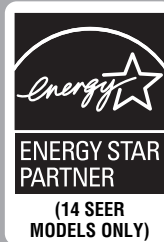

DO NOT DESTROY THIS MANUAL
PLEASE READ CAREFULLY AND KEEP IN A SAFE PLACE FOR FUTURE REFERENCE BY A SERVICEMAN

TABLE OF CONTENTS

I. Safety Information	3
II. Introduction.....	4
III. Checking Product Received	7
IV. Equipment Protection	7
V. Specifications	7
VI. Installation	7
A. General	7
1. Pre-Installation Check Points	7
2. Location.....	7
B. Outside Slab Installation	8
C. Clearances	8
D. Rooftop Installation	9
VII. Ductwork.....	9
VIII. Filters.....	9
IX. Condensate Drain, Indoor Coil	9
X. Condensate Drain, Outdoor Coil	10
XI. Electrical Wiring.....	10
A. Power Wiring.....	10
B. Electric Heater Kit Instructions	10
C. Control Wiring	11
D. Internal Wiring	11
E. Grounding	11
F. Thermostat	12
XII. Indoor Air Flow Data.....	12
XIII. Pre-Start Check	12
XIV. Startup	12
XV. Operation.....	13
XVI. Auxiliary Heat	13
XVII. Demand Defrost Control.....	14
XVIII. General Data	15-20
XIX. Miscellaneous	
Electrical and Physical Data.....	21-22
Airflow Performance	23-26
Electric Heater Kit.....	27-30
Wiring Diagram.....	31-34
Charge Charts	35-40

► Installation instructions are updated on a regular basis. This is done as product changes occur or if new information becomes available. In this publication, an arrow (►) denotes changes from the previous edition or additional new material.

I. SAFETY INFORMATION

WARNING

THESE INSTRUCTIONS ARE INTENDED AS AN AID TO QUALIFIED, LICENSED SERVICE PERSONNEL FOR PROPER INSTALLATION, ADJUSTMENT AND OPERATION OF THIS UNIT. READ THESE INSTRUCTIONS THOROUGHLY BEFORE ATTEMPTING INSTALLATION OR OPERATION. FAILURE TO FOLLOW THESE INSTRUCTIONS MAY RESULT IN IMPROPER INSTALLATION, ADJUSTMENT, SERVICE OR MAINTENANCE POSSIBLY RESULTING IN FIRE, ELECTRICAL SHOCK, PROPERTY DAMAGE, PERSONAL INJURY OR DEATH.

WARNING

PROPOSITION 65: THIS APPLIANCE CONTAINS FIBERGLASS INSULATION. RESPIRABLE PARTICLES OF FIBERGLASS ARE KNOWN TO THE STATE OF CALIFORNIA TO CAUSE CANCER.

WARNING

THE MANUFACTURER'S WARRANTY DOES NOT COVER ANY DAMAGE OR DEFECT TO THE HEAT PUMP CAUSED BY THE ATTACHMENT OR USE OF ANY COMPONENTS, ACCESSORIES OR DEVICES (OTHER THAN THOSE AUTHORIZED BY THE MANUFACTURER) INTO, ONTO OR IN CONJUNCTION WITH THE HEAT PUMP. YOU SHOULD BE AWARE THAT THE USE OF UNAUTHORIZED COMPONENTS, ACCESSORIES OR DEVICES MAY ADVERSELY AFFECT THE OPERATION OF THE HEAT PUMP AND MAY ALSO ENDANGER LIFE AND PROPERTY. THE MANUFACTURER DISCLAIMS ANY RESPONSIBILITY FOR SUCH LOSS OR INJURY RESULTING FROM THE USE OF SUCH UNAUTHORIZED COMPONENTS, ACCESSORIES OR DEVICES.

WARNING

DISCONNECT ALL POWER TO THE UNIT BEFORE STARTING MAINTENANCE. FAILURE TO DO SO CAN RESULT IN SEVERE ELECTRICAL SHOCK OR DEATH.

WARNING

DO NOT, UNDER ANY CIRCUMSTANCES, CONNECT RETURN DUCTWORK TO ANY OTHER HEAT PRODUCING DEVICE SUCH AS A FIREPLACE INSERT, STOVE, ETC. UNAUTHORIZED USE OF SUCH DEVICES MAY RESULT IN FIRE, CARBON MONOXIDE POISONING, EXPLOSION, PROPERTY DAMAGE, SEVERE PERSONAL INJURY OR DEATH.

WARNING

TURN OFF ELECTRIC POWER AT THE FUSE BOX OR SERVICE PANEL BEFORE MAKING ANY ELECTRICAL CONNECTIONS.

ALSO, THE GROUND CONNECTION MUST BE COMPLETED BEFORE MAKING LINE VOLTAGE CONNECTIONS. FAILURE TO DO SO CAN RESULT IN ELECTRICAL SHOCK, SEVERE PERSONAL INJURY OR DEATH.

WARNING

THE UNIT MUST BE PERMANENTLY GROUNDED. A GROUNDING LUG IS PROVIDED. FAILURE TO GROUND THIS UNIT CAN RESULT IN FIRE OR ELECTRICAL SHOCK CAUSING PROPERTY DAMAGE, SEVERE PERSONAL INJURY OR DEATH.

WARNING

ONLY ELECTRIC HEATER KITS SUPPLIED BY THIS MANUFACTURER AS DESCRIBED IN THIS PUBLICATION HAVE BEEN DESIGNED, TESTED, AND EVALUATED BY A NATIONALLY RECOGNIZED SAFETY TESTING AGENCY FOR USE WITH THIS UNIT. USE OF ANY OTHER MANUFACTURED ELECTRIC HEATERS INSTALLED WITHIN THIS UNIT MAY CAUSE HAZARDOUS CONDITIONS RESULTING IN PROPERTY DAMAGE, FIRE, BODILY INJURY OR DEATH.

WARNING

PROPOSITION 65: THIS APPLIANCE CONTAINS FIBERGLASS INSULATION. RESPIRABLE PARTICLES OF FIBERGLASS ARE KNOWN TO THE STATE OF CALIFORNIA TO CAUSE CANCER.

WARNING

THE MANUFACTURER'S WARRANTY DOES NOT COVER ANY DAMAGE OR DEFECT TO THE HEAT PUMP CAUSED BY THE ATTACHMENT OR USE OF ANY COMPONENTS, ACCESSORIES OR DEVICES (OTHER THAN THOSE AUTHORIZED BY THE MANUFACTURER) INTO, ONTO OR IN CONJUNCTION WITH THE HEAT PUMP. YOU SHOULD BE AWARE THAT THE USE OF UNAUTHORIZED COMPONENTS, ACCESSORIES OR DEVICES MAY ADVERSELY AFFECT THE OPERATION OF THE HEAT PUMP AND MAY ALSO ENDANGER LIFE AND PROPERTY. THE MANUFACTURER DISCLAIMS ANY RESPONSIBILITY FOR SUCH LOSS OR INJURY RESULTING FROM THE USE OF SUCH UNAUTHORIZED COMPONENTS, ACCESSORIES OR DEVICES.

II. INTRODUCTION

This booklet contains the installation and operating instructions for your package heat pump. There are a few precautions that should be taken to derive maximum satisfaction from it. Improper installation can result in unsatisfactory operation or dangerous conditions.

Read this booklet and any instructions packaged with separate equipment required to make up the system prior to installation. Give this booklet to the owner and explain its provisions. The owner should retain this booklet for future reference.

NOTE: A load calculation must be performed to properly determine the required heating and cooling for the structure. Also, the duct must be properly designed and installed for proper airflow. Existing ductwork must be inspected for proper size and sealed system. Proper airflow is necessary for both user comfort and equipment performance.

IMPORTANT: Proper application, installation and maintenance of this equipment is a must if consumers are to receive the full benefit for which they have paid.

A. R-410A REFRIGERANT

All units are factory charged with R-410A refrigerant.

1. Specification of R-410A:

Application: **R-410A is not a drop-in replacement for R-22;** equipment designs must accommodate its higher pressures. It cannot be retrofitted into R-22 units.

Pressure: **The pressure of R-410A is approximately 60% (1.6 times) greater than R-22.** Recovery and recycle equipment, pumps, hoses and the like need to have design pressure ratings appropriate for R-410A. *Manifold sets need to range up to 800 psig high-side and 250 psig low-side with a 550 psig low-side retard. Hoses need to have a service pressure rating of 800 psig. Recovery cylinders need to have a 400 psig service pressure rating.* DOT 4BA400 or DOT BW400.

Combustibility: At pressures above 1 atmosphere, mixture of R-410A and air can become combustible. **R-410A and air should never be mixed in tanks or supply lines, or be allowed to accumulate in storage tanks. Leak checking should never be done with a mixture of R-410A and air.** Leak checking can be performed safely with nitrogen or a mixture of R-410A and nitrogen.

2. Quick Reference Guide For R-410A

- R-410A refrigerant operates at approximately 60% higher pressure (1.6 times) than R-22. Ensure that servicing equipment is designed to operate with R-410A.
- R-410A refrigerant cylinders are pink.
- R-410A, as with other HFC's is only compatible with POE oils.
- Vacuum pumps will not remove moisture from POE oil.
- R-410A systems are to be charged with liquid refrigerants. Prior to March 1999, R-410A refrigerant cylinders had a dip tube. These cylinders should be kept upright for equipment charging. Post March 1999 cylinders do not have a dip tube and should be inverted to ensure liquid charging of the equipment.
- Do not install a suction line filter drier in the liquid line.
- A liquid line filter drier is standard on every unit.
- Desiccant (drying agent) must be compatible for POE oils and R-410A.

3. Evaporator Coil / TXV

The thermostatic expansion valve is specifically designed to operate with R-410A. **DO NOT use an R-22 TXV. The existing evaporator must be replaced with the factory specified TXV evaporator specifically designed for R-410A.**

4. Tools Required For Installing & Servicing R-410A Models

Manifold Sets:

- Up to 800 PSIG High side
- Up to 250 PSIG Low Side
- 550 PSIG Low Side Retard

Manifold Hoses:

- Service Pressure Rating of 800 PSIG

Recovery Cylinders:

- 400 PSIG Pressure Rating
- Dept. of Transportation 4BA400 or BW400

CAUTION

R-410A systems operate at higher pressures than R-22 systems. Do not use R-22 service equipment or components on R-410A equipment.

FIGURE 1
UNIT DIMENSIONS AND ACCESS LOCATIONS

Model	Height "A"
024, 030, 036	29 1/8"
042, 048, 060	37 1/8"

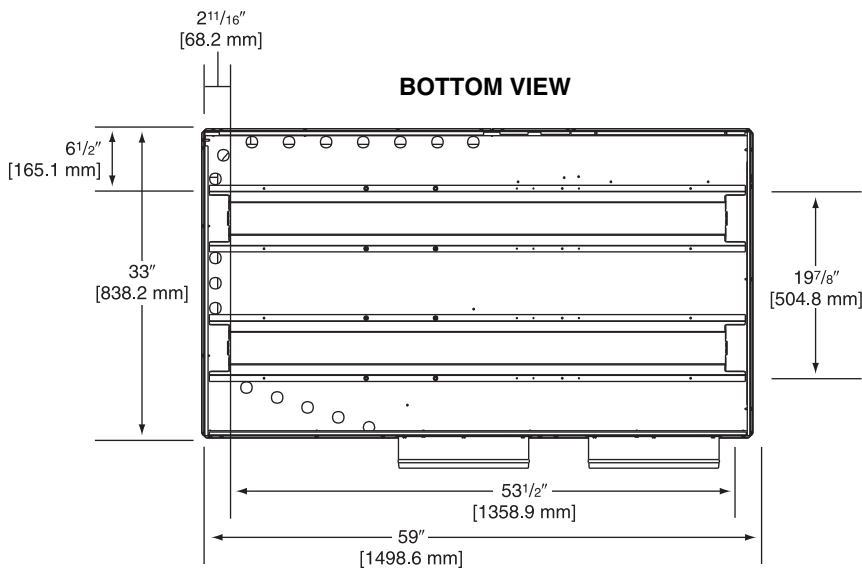
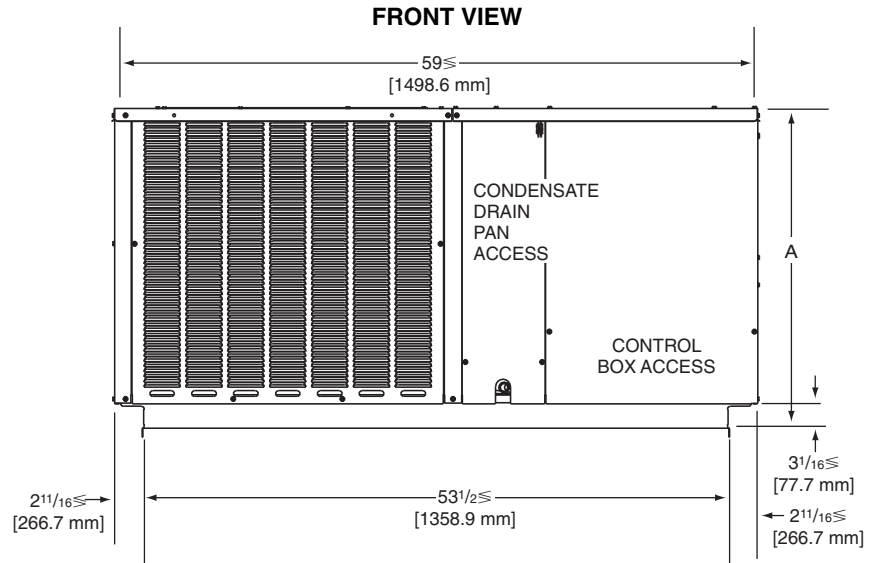

ELECTRICAL CONNECTIONS

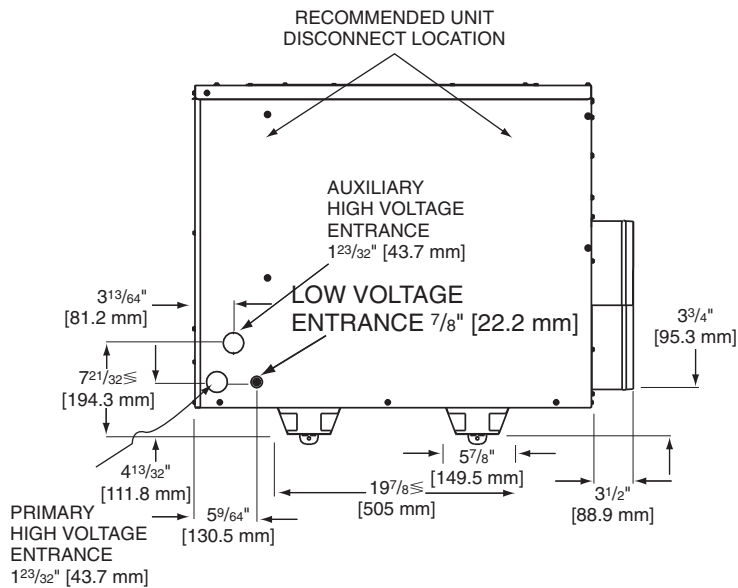

DUCT CONNECTIONS

ROUND DUCT CONNECTIONS

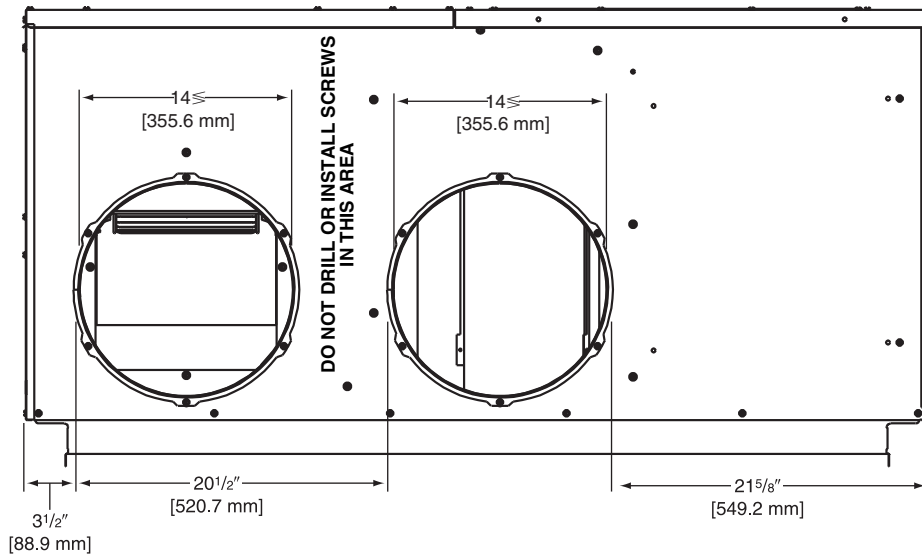

SQUARE DUCT CONNECTIONS

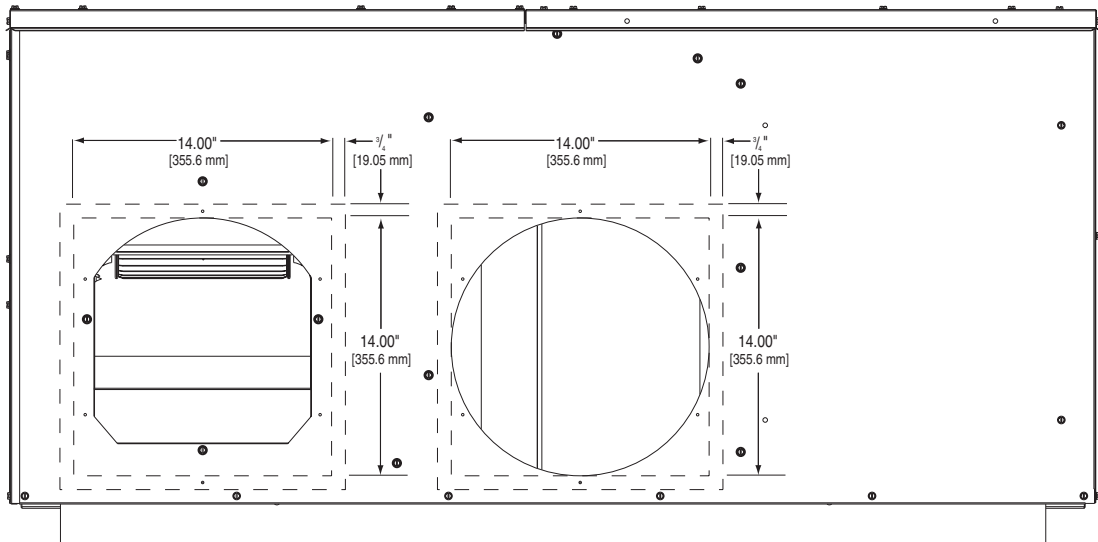

IMPORTANT: DO NOT SCREW OR DRILL OUTSIDE THE DESIGNATED AREAS.

III. CHECKING PRODUCT RECEIVED

Upon receiving the unit, inspect it for any damage from shipment. Claims for damage, either shipping or concealed, should be filed immediately with the shipping company. Check the unit model number, heating size, electrical characteristics, and accessories to determine if they are correct.

IV. EQUIPMENT PROTECTION FROM THE ENVIRONMENT

The metal parts of this unit may be subject to rust or deterioration in adverse environmental conditions. This oxidation could shorten the equipment's useful life. Salt spray, fog or mist in seacoast areas, sulphur or chlorine from lawn watering systems, and various chemical contaminants from industries such as paper mills and petroleum refineries are especially corrosive.

If the unit is to be installed in an area where contaminants are likely to be a problem, special attention should be given to the equipment location and exposure.

1. Avoid having lawn sprinkler heads spray direction on the unit cabinet.
2. In coastal areas, locate the unit on the side of the building away from the waterfront.
3. Shielding provided by a fence or shrubs may give some protection.
4. Elevating the unit off its slab or base enough to allow air circulation will help avoid holding water against the basepan.

Regular maintenance will reduce the buildup of contaminants and help to protect the unit's finish.

WARNING

DISCONNECT ALL POWER TO THE UNIT BEFORE STARTING MAINTENANCE. FAILURE TO DO SO CAN RESULT IN SEVERE ELECTRICAL SHOCK OR DEATH.

1. Frequent washing of the cabinet, fan blade and coil with fresh water will remove most of the salt or other contaminants that build up on the unit.
2. Regular cleaning and waxing of the cabinet with an automobile polish will provide some protection.
3. A liquid cleaner may be used several times a year to remove matter that will not wash off with water.

Several different types of protective coatings are offered in some areas. These coatings may provide some benefit, but the effectiveness of such coating materials cannot be verified by the equipment manufacturer.

The best protection is frequent cleaning, maintenance and minimal exposure to contaminants.

V. SPECIFICATIONS

Suitable for use in mobile homes, manufactured housing, and conventionally constructed residential and commercial buildings where horizontally-ducted systems are preferred.

VI. INSTALLATION

A. GENERAL

1. PRE-INSTALLATION CHECK-POINTS

Before attempting any installation, the following points should be carefully considered:

- a. Structural strength of supporting members.
(rooftop installation)
- b. Clearances and provision for servicing.
- c. Power supply and wiring.
- d. Air duct connections.
- e. Drain facilities and connections.
- f. Location for minimum noise.

2. LOCATION

These units are designed for outdoor installations. They can be mounted on a slab or rooftop. They are not to be installed within any part of a structure such as an attic, crawl space, closet, or any other place where condenser air flow is restricted or other than outdoor ambient conditions prevail. Since the application of the units is of the outdoor type, it is important to consult your local code authorities at the time the first installation is made.

FIGURE 2
PACKAGED HEAT PUMP
 OUTSIDE SLAB INSTALLATION, BASEMENT OR
 CRAWL SPACE DISTRIBUTION SYSTEM

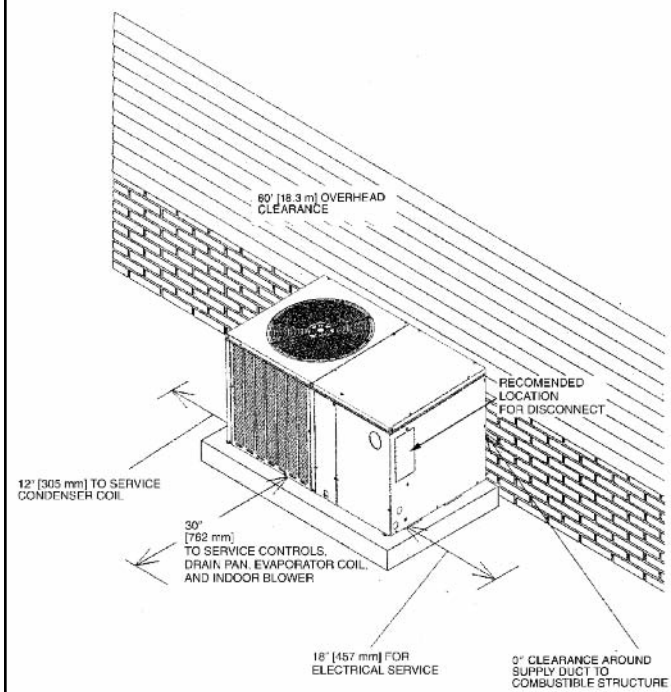
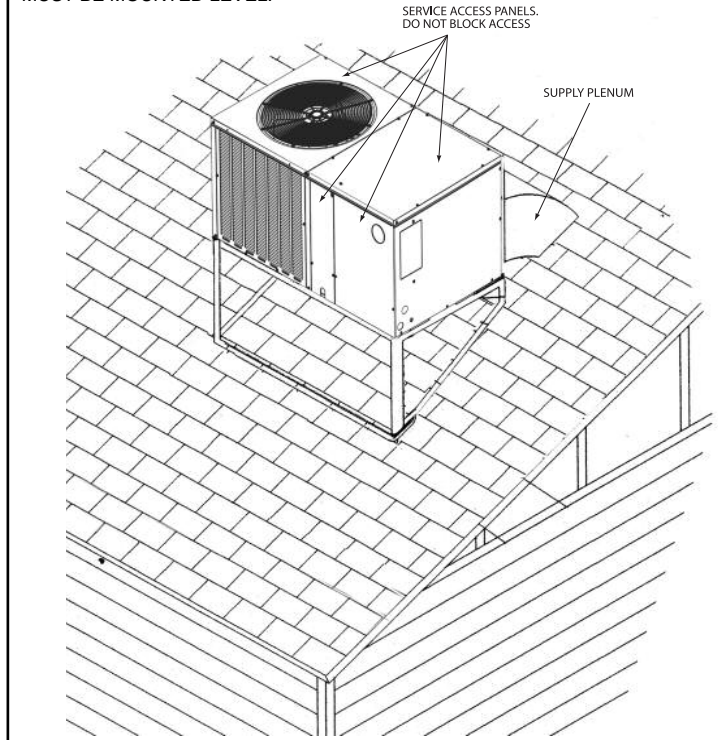

FIGURE 3
PACKAGED HEAT PUMP
 PITCHED ROOFTOP INSTALLATION, ATTIC
 OR DROP CEILING DISTRIBUTING SYSTEM.
 MUST BE MOUNTED LEVEL.



B. OUTSIDE SLAB INSTALLATION (Typical outdoor slab installations are shown in Figure 2.)

1. Select a location where external water drainage cannot collect around the unit.
2. Provide a level concrete slab extending 3" beyond all four sides of the unit. The slab should be sufficient above grade to prevent ground water from entering the unit.

IMPORTANT: To prevent transmission of noise or vibration, slab should not be connected to building structure.

3. The location of the unit should be such as to provide proper access for inspection and servicing.
4. Locate unit where operating sounds will not disturb owner or neighbors.
5. Locate unit so roof runoff water does not pour directly on the unit. Provide gutter or other shielding at roof level. Do not locate unit in an area where excessive snow drifting may occur or accumulate.
6. It is essential that the unit be elevated above the base pad to allow for condensate drainage and possible refreezing of condensation. Provide a base pad which is slightly pitched away from the structure. Route condensate off base pad to an area which will not become slippery and result in personal injury.

IMPORTANT: Avoid blocking openings in bottom of unit.

7. Where snowfall is anticipated, the height of the unit above the ground level must be considered. Mount unit high enough to be above average area snowfall and to allow for proper condensate drainage.

IMPORTANT: Avoid blocking openings in bottom of unit.

C. CLEARANCES

The following minimum clearances must be observed for proper unit performance and serviceability.

1. Provide 30" minimum clearance at the front and 18" on the right side of the unit for service access. Provide 12" minimum clearance on the left side of the unit for air inlet.
2. Provide 60" minimum clearance from top of unit.

3. Unit is design certified for application on combustible flooring with 0" minimum clearance.
4. See Figure 2 for illustration of minimum installation-service clearances.

D. ROOFTOP INSTALLATION

1. Before locating the unit on the roof, make sure that the strength of the roof and beams is adequate at that point to support the weight involved. (See specification sheet for weight of unit.) This is very important and user's responsibility.
2. The unit should be placed on a solid and level platform of adequate strength.

IMPORTANT: Avoid blocking openings in bottom of unit. (See Figure 3). Provision for disposal of outdoor coil defrost water runoff must be provided.

3. The location of the unit on the roof should be such as to provide proper access for inspection and servicing.

IMPORTANT: If unit will not be put into service immediately, cover supply and return openings to prevent excessive condensation.

VII. DUCTWORK

Ductwork should be fabricated by the installing contractor in accordance with local codes and NFPA90A. Industry manuals may be used as a guide when sizing and designing the duct system - contact Air Conditioning Contractors of America, 1513 16th St. N.W., Washington, D.C. 20036.

WARNING

DO NOT, UNDER ANY CIRCUMSTANCES, CONNECT RETURN DUCTWORK TO ANY OTHER HEAT PRODUCING DEVICE SUCH AS A FIREPLACE INSERT, STOVE, ETC. UNAUTHORIZED USE OF SUCH DEVICES MAY RESULT IN FIRE, CARBON MONOXIDE POISONING, EXPLOSION, PROPERTY DAMAGE, SEVERE PERSONAL INJURY OR DEATH.

Place the unit as close to the space to be air conditioned as possible allowing clearance dimensions as indicated. Run ducts as directly as possible to supply and return outlets. Use of non-flammable waterproof flexible connectors on both supply and return connections at the unit to reduce noise transmission is recommended.

It is preferable to install the unit on the roof of the structure if the registers or diffusers are located on the wall or in the ceiling. Consider a slab installation when the registers are low on a wall or in the floor.

On ductwork exposed to outside air conditions of temperature and humidity, use a minimum of 2" of insulation and a vapor barrier. Distribution system in attic, furred space or crawl space should be insulated with at least 2" of insulation with vapor barrier. One-half to 1" thickness of insulation is usually sufficient for ductwork inside the air conditioned space.

Provide balancing dampers for each branch duct in the supply system. Properly support the ductwork from the structure.

VIII. FILTERS

Filters are not provided with this unit. They must be supplied and installed in the return air duct by the installer. A field installed filter grille is recommended for easy and convenient access to the filters for periodic inspection and cleaning. Filters must have adequate face area for the rated air quantity of the unit. See General Database for recommended filter size.

IX. CONDENSATE DRAIN

The indoor coil condensate drain ends with a PVC stub. A trap is provided in for proper condensate drainage and to prevent debris from being drawn into the unit. Do not connect drain to closed sewer line. It is not recommended that a PVC cement or other permanent installation be used so that the drain line and/or drain pan can be easily cleaned in the future. The drain trap is located in the control box during shipping. To install, slide clear plastic tube over drain pan connection. The white PVC trap can be oriented as required by installation.

X. CONDENSATE DRAIN, OUTDOOR COIL

The outdoor coil during heating operation will sweat or run water off. The outdoor coil will also run water off during the defrost cycle. See Section V, Installation, for mounting precautions.

FIGURE 4
REMOVABLE CONDENSATE
DRAIN PAN AND REMOVAL
PROCEDURE

A small side panel grants access to a removable, sloped drain pan (A), which helps to ensure indoor air quality (IAQ) throughout the life of the unit. A drain trap (B) assembly is provided for convenience.

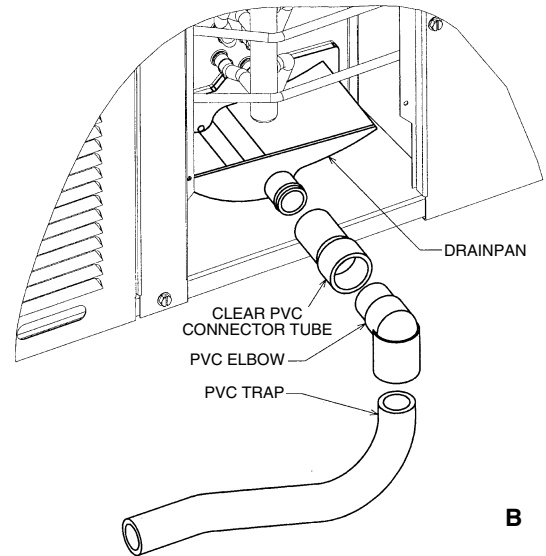

XI. ELECTRICAL WIRING

Field wiring must comply with the National Electrical Code* and applicable local codes.

*C.E.C. in Canada

A. POWER WIRING

1. It is important that proper electrical power is available at the unit. Voltage should not vary more than 10% from that stamped on the unit rating plate. On three phase units, phases must be balanced within 3%.
2. Install a branch circuit disconnect within sight of the unit and of adequate size to handle the starting current. (See Heater Kit Tables.)
3. For branch circuit wiring (main power supply to unit disconnect), the minimum wire size can be determined from the National Electrical Code or nameplate or from Heater Kit Tables.
4. This unit supports both single and dual point electrical connection for unit and electric heat accessory.
5. Power wiring must be run in grounded rain-tight conduit.

B. POWER WIRING AND ELECTRIC HEATER KIT INSTRUCTIONS

1. Turn off power to unit.
2. Remove control box access panel.
3. Remove unit indoor section top cover.
4. Remove wire notch cover from control bulkhead and discard. Retain screw.
5. Remove heater element cover plate from blower outlet opening and discard. Retain screws.
6. Mount heater fuse block assembly in location indicated with the three included screws.
7. Route wire harness assembly through wire notch in control bulkhead and mount element assembly in blower outlet opening with screws previously retained.
8. Center wire routing plate over notch in blower bulkhead and secure with screw previously retained.
9. Route and tie wiring as shown in Figure 5. Wiring must not contact moving parts or uninsulated electrical connections.
10. Replace unit indoor top cover.
11. Connect power and control wiring as indicated below:
 - a. **Single-point wiring:** Connect high voltage field power leads to heater kit fuse block and connect included unit power pigtailed from heater kit fuse block to unit

⚠ WARNING

TURN OFF ELECTRIC POWER AT THE FUSE BOX OR SERVICE PANEL BEFORE MAKING ANY ELECTRICAL CONNECTIONS.

ALSO, THE GROUND CONNECTION MUST BE COMPLETED BEFORE MAKING LINE VOLTAGE CONNECTIONS. FAILURE TO DO SO CAN RESULT IN ELECTRICAL SHOCK, SEVERE PERSONAL INJURY OR DEATH.

contactor L1 and L3 connections. Connect ground lead to ground lug on heater kit fuse block.

b. **Dual-circuit wiring:** Remove unit power pigtailed from heater kit fuse block and discard. Connect one set of high voltage field power circuit leads to the heater kit fuse block and connect ground lead to ground lug on heater kit fuse block.

Connect the second set of high voltage field power leads to L1 and L3 on the unit contactor. Connect ground lead to ground lug on control box bulkhead.

c. Connect heater kit control plug to receptacle in control box.

12. Replace control box access panel.

13. Restore power to unit and verify proper unit and heater kit operation.

C. CONTROL WIRING (Class II)

1. Do not run low voltage wiring in conduit with power wiring.

2. Control wiring is routed through the 7/8" hole corner adjacent to the control box. See Electrical Connections, Figure 1. Use a minimum #18 AWG thermostat wire. For wire lengths exceeding 50', use #16 AWG thermostat wire. The low voltage wires are connected to the unit pigtailed which are supplied with the unit in the low voltage connection box located within the unit control box. See Figure 5.

3. It is necessary that only heat pump thermostats be used.

4. Figure 6 shows representative low voltage connection diagrams. Read your thermostat installation instructions for any special requirements for your specific thermostat.

FIGURE 5
HEATER KIT INSTALLATION



RECOMMENDED
WIRING

HEATER
ELEMENTS

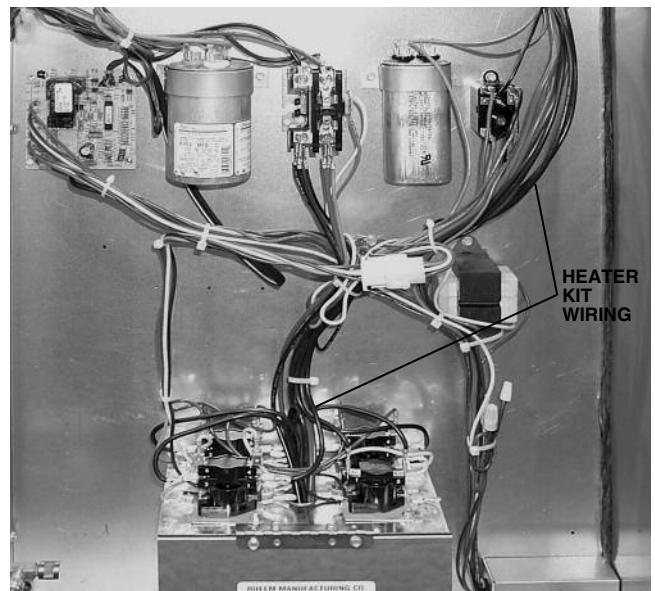

HEATER
KIT
WIRING

NOTE — Units installed in Canada require that an outdoor thermostat (30,000 min. cycles of endurance) be installed and be wired with C.E.C. Class I wiring.

D. INTERNAL WIRING

1. A diagram of the internal wiring of this unit is located on the electrical control box cover. If any of the original wire as supplied with the appliance must be replaced, the wire gauge and insulation must be the same as original wiring.

E. GROUNDING

⚠ WARNING

THE UNIT MUST BE PERMANENTLY GROUNDED. A GROUNDING LUG IS PROVIDED. FAILURE TO GROUND THIS UNIT CAN RESULT IN FIRE OR ELECTRICAL SHOCK CAUSING PROPERTY DAMAGE, SEVERE PERSONAL INJURY OR DEATH.

F. THERMOSTAT

Mount the thermostat on an inside wall about five feet above the floor in a location where it will not be affected by unconditioned air, sun, or drafts from open doors or other sources. READ installation instructions in heat pump thermostat package CAREFULLY because each has some different wiring requirements.

XII. INDOOR AIR FLOW DATA

All 208/230 volt units are equipped with multi-speed indoor blower motors. Each unit is shipped factory wired for the proper speed at a normal external static. See Airflow Performance Table for blower performance.

XIII. PRE-START CHECK

1. Is unit properly located and level?
2. Is ductwork insulated, weatherproofed, with proper spacing to combustible materials?
3. Is air free to travel to and from outdoor coil? (See Figure 1.)

FIGURE 6
VOLTAGE CONNECTIONS DIAGRAM

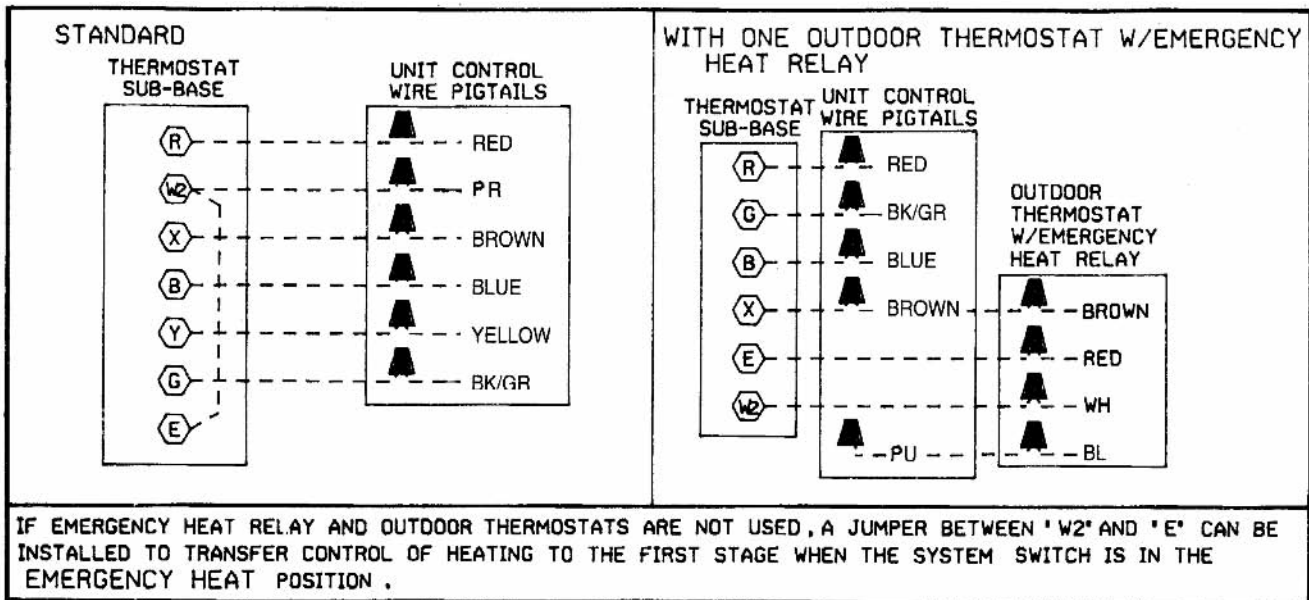

4. Is the wiring correct, tight, and according to unit wiring diagram?
5. Is unit grounded?
6. Are field supplied air filters in place and clean?
7. Do the outdoor fan and indoor blower turn freely without rubbing, and are they tight on the motor shafts?
8. Has crankcase heat been on for at least 12 hours?
9. Is unit elevated to allow for outdoor coil condensate drainage during heating operation and defrost?

XIV. STARTUP

1. Turn thermostat to "OFF," turn "on" power supply at disconnect switch.
2. Turn temperature setting as high as it will go.
3. Turn fan switch to "ON."
4. Indoor blower should run. Be sure it is running in the right direction.
5. Turn fan switch to "AUTO." Turn system switch to "COOL" and turn temperature setting below room temperature. Unit should run in cooling mode.
6. Is outdoor fan operating correctly in the right direction?

7. Is compressor running correctly.
8. Turn thermostat system switch to "HEAT." Unit should stop. Wait 5 minutes, then raise temperature setting to above room temperature. Unit should run in heating mode and after about 30 to 50 seconds auxiliary heaters, if installed, should come on.
9. Check the refrigerant charge using the instructions located on control box cover. Replace service port caps. Service port cores are for system access only and will leak if not tightly capped.
- 10 Turn thermostat system switch to proper mode "HEAT" or "COOL" and set thermostat to proper temperature setting. Record the following after the unit has run some time.
 - A. Operating Mode _____
 - B. Discharge Pressure (High) _____ PSIG
 - C. Vapor Pressure at Compressor (Low) _____ PSIG
 - D. Vapor Line Temperature at Compressor _____ °F.
 - E. Indoor Dry Bulb _____ °F.
 - F. Indoor Wet Bulb _____ °F.
 - G. Outdoor Dry Bulb _____ °F.
 - H. Outdoor Wet Bulb _____ °F.
 - I. Voltage at Contactor _____ Volts
 - J. Current at Contactor _____ Amps
 - K. Model Number _____
 - L. Serial Number _____
 - M. Location _____
 - N. Owner _____
 - O. Date _____
11. Adjust discharge air grilles and balance system.
12. Check ducts for condensation and air leaks.
13. Check unit for tubing and sheet metal rattles.
14. Instruct the owner on operation and maintenance.
15. Leave "USE AND CARE" instructions with owner.

XV. OPERATION

Most single phase units are not equipped with start relay or start capacitor. It is important that such systems be off for a minimum of 5 minutes before restarting to allow equalization of pressures. Do not move the thermostat to cycle unit without waiting five minutes. To do so may cause the compressor to stop on an automatic open overload device or blow a fuse. Poor electrical service can cause nuisance tripping in overloads or blow fuses.

IMPORTANT: *The compressor has an internal overload protector. Under some conditions, it can take up to 2 hours for this overload to reset. Make sure overload has had time to reset before condemning the compressor.*

These units are equipped with a time delay control (TDC1). The control allows the blower to operate for 45 to 90 seconds after the thermostat is satisfied.

XVI. AUXILIARY HEAT

The amount of auxiliary heat required depends on the heat loss of the structure to be heated and the capacity of the heat pump. It is good practice to install strip heat to maintain at least 60°F indoor temperatures in case of compressor failure. The auxiliary heat is energized by the first stage of the thermostat. The amount of electric heat that is allowed to come on, as determined by the output of the heat pump, may be controlled by an outdoor thermostat.

WARNING

ONLY ELECTRIC HEATER KITS SUPPLIED BY THIS MANUFACTURER AS DESCRIBED IN THIS PUBLICATION HAVE BEEN DESIGNED, TESTED, AND EVALUATED BY A NATIONALLY RECOGNIZED SAFETY TESTING AGENCY FOR USE WITH THIS UNIT. USE OF ANY OTHER MANUFACTURED ELECTRIC HEATERS INSTALLED WITHIN THIS UNIT MAY CAUSE HAZARDOUS CONDITIONS RESULTING IN PROPERTY DAMAGE, FIRE, BODILY INJURY OR DEATH.

A. CONTROL SYSTEM OPERATION

1. In the cooling mode, the thermostat will, on a call for cooling, energize the compressor contactor and the indoor blower relay. The indoor blower can be operated continuously by setting the thermostat fan switch at the "ON" position.

2. In the heating mode, the first heat stage of the thermostat will energize one or more supplementary resistance heaters. If required or considered desirable, the resistance heat may also be controlled by outdoor thermostats. In the heating mode, the thermostat will, on a call for heating, energize the indoor blower relay.

XVII. DEMAND DEFROST CONTROL

The demand defrost control is a printed circuit board assembly consisting of solid state control devices with electro-mechanical outputs. The demand defrost control monitors the outdoor ambient temperature, outdoor coil temperature, and the compressor run-time to determine when a defrost cycle is required.

DEFROST INITIATION

A defrost will be initiated when the three conditions below are satisfied:

- 1) The outdoor coil temperature is below 35°F.
- 2) The compressor has operated for at least 34 minutes with the outdoor coil temperature below 35°F.
- 3) The measured difference between the ambient temperature and the outdoor coil temperature is greater than the calculated delta T.

Additionally, a defrost will be initiated if six hours of accumulated compressor run-time has elapsed without a defrost with the outdoor coil temperature below 35°F.

DEFROST TERMINATION

Once a defrost is initiated, the defrost will continue until fourteen minutes has elapsed **or** the coil temperature has reached the terminate temperature. The terminate temperature is factory set at 70°F, although the temperature can be changed to 50°F, 60°F, 70°F or 80°F by relocating a jumper on the board.

TEMPERATURE SENSORS

The coil sensor is clipped to the top tube on the outdoor coil at the point fed by the distribution tubes from the expansion device (short 3/8" dia. tube). The air sensor is located behind the compressor access panel.

If the ambient sensor fails the defrost control will initiate a defrost every 34 minutes with the coil temperature below 35°F.

If the coil sensor fails the defrost control will not initiate a defrost.

TEST MODE

The test mode is initiated by shorting the TEST pins. In this mode of operation, the enable temperature is ignored and all timers are sped up by a factor of 240. To initiate a manual defrost, short the TEST pins. Remove the short when the system switches to defrost mode. The defrost will terminate on time (14 minutes) or when the termination temperature has been achieved. *Short TEST pins again to terminate the defrost immediately.*

TROUBLE SHOOTING DEMAND DEFROST

Set the indoor thermostat select switch to heat and thermostat lever to a call for heat.

Jumper the "test pins" to put the unit into defrost. If the unit goes into defrost and comes back out of defrost, the indication is that the control is working properly.

If the unit did not go into defrost using the test pins, check to ensure that 24V is being supplied to the control board. If 24V is present then replace the control.

XVIII. GENERAL DATA - RQPM

NOMINAL SIZES 2-5 TONS [7-17.6 kW]

Model RQPM- Series	A024JK	A030JK	A036CK	A036JK
Cooling Performance¹				Continued ->
Gross Cooling Capacity Btu [kW]	24,000 [7.03]	29,400 [8.61]	36,000 [10.55]	36,000 [10.55]
EER/SEER ²	12/14	12.05/14	11.6/14	11.6/14
Nominal CFM/ARI Rated CFM [L/s]	800/800 [378/378]	1000/1000 [472/472]	1200/1200 [566/566]	1200/1200 [566/566]
ARI Net Cooling Capacity Btu [kW]	23,600 [6.91]	29,000 [8.5]	35,400 [10.37]	35,400 [10.37]
Net Sensible Capacity Btu [kW]	18,400 [5.39]	23,000 [6.74]	27,600 [8.09]	27,600 [8.09]
Net Latent Capacity Btu [kW]	5,200 [1.52]	6,000 [1.76]	7,800 [2.29]	7,800 [2.29]
Net System Power kW	2	2.41	3.05	3.05
Heating Performance (Heat Pumps)³				
High Temp. Btuh [kW] Rating	23,200 [6.8]	28,000 [8.2]	34,200 [10.02]	34,200 [10.02]
System Power KW / COP	1.93/3.5	2.27/3.62	2.78/3.6	2.78/3.6
Low Temp. Btuh [kW] Rating	13,200 [3.87]	15,200 [4.45]	19,000 [5.57]	19,000 [5.57]
System Power KW / COP	1.71/2.26	2.01/2.22	2.48/2.24	2.48/2.24
HSPF (Btu/Watts-hr)	8	8	8	8
Compressor				
No./Type	1/Copeland Scroll	1/Copeland Scroll	1/Copeland Scroll	1/Copeland Scroll
Outdoor Sound Rating (dB)⁴	76	76	76	76
Outdoor Coil - Fin Type	Louvered	Louvered	Louvered	Louvered
Tube Type	Rifled	Rifled	Rifled	Rifled
Tube Size in. [mm] OD	0.375 [9.5]	0.375 [9.5]	0.375 [9.5]	0.375 [9.5]
Face Area sq. ft. [sq. m]	10.44 [0.97]	12.65 [1.18]	12.65 [1.18]	12.65 [1.18]
Rows / FPI [FPcm]	1 / 20 [8]	1 / 20 [8]	1 / 20 [8]	1 / 20 [8]
Refrigerant Control	TX Valves	TX Valves	TX Valves	TX Valves
Indoor Coil - Fin Type	Louvered	Louvered	Louvered	Louvered
Tube Type	Rifled	Rifled	Rifled	Rifled
Tube Size in. [mm]	0.375 [9.5]	0.375 [9.5]	0.375 [9.5]	0.375 [9.5]
Face Area sq. ft. [sq. m]	4.33 [0.4]	4.33 [0.4]	4.33 [0.4]	4.33 [0.4]
Rows / FPI [FPcm]	2 / 15 [6]	3 / 13 [5]	3 / 13 [5]	3 / 13 [5]
Refrigerant Control	TX Valves	TX Valves	TX Valves	TX Valves
Drain Connection No./Size in. [mm]	1/1 [25.4]	1/1 [25.4]	1/1 [25.4]	1/1 [25.4]
Outdoor Fan - Type	Propeller	Propeller	Propeller	Propeller
No. Used/Diameter in. [mm]	1/24 [609.6]	1/24 [609.6]	1/24 [609.6]	1/24 [609.6]
Drive Type/No. Speeds	Direct/1	Direct/1	Direct/1	Direct/1
CFM [L/s]	3200 [1510]	3200 [1510]	3200 [1510]	3200 [1510]
No. Motors/HP	1 at 1/3 HP	1 at 1/3 HP	1 at 1/3 HP	1 at 1/3 HP
Motor RPM	825	825	825	825
Indoor Fan - Type	FC Centrifugal	FC Centrifugal	FC Centrifugal	FC Centrifugal
No. Used/Diameter in. [mm]	1/10x9 [254x228.6]	1/10x9 [254x228.6]	1/10x9 [254x228.6]	1/10x9 [254x228.6]
Drive Type/No. Speeds	Direct/2	Direct/2	Direct/2	Direct/2
No. Motors	1	1	1	1
Motor HP	1/2	1/2	1/2	1/2
Motor RPM	1050	1050	1050	1050
Motor Frame Size	48	48	48	48
Filter - Type	Field Supplied	Field Supplied	Field Supplied	Field Supplied
Furnished	No	No	No	No
(NO.) Size Recommended in. [mm x mm x mm]	(1)1x20x16 [25x508x406]	(1)1x20x20 [25x508x508]	(1)1x24x24 [25x610x610]	(1)1x24x24 [25x610x610]
Refrigerant Charge Oz. [g]	90 [2552]	93 [2637]	93 [2637]	93 [2637]
Weights				
Net Weight lbs. [kg]	308 [140]	331 [150]	356 [161]	356 [161]
Ship Weight lbs. [kg]	332 [151]	355 [161]	380 [172]	380 [172]

NOTES:

- Cooling Performance is rated at 95° F ambient, 80° F entering dry bulb, 67° F entering wet bulb. Gross capacity does not include the effect of fan motor heat. ARI capacity is net and includes the effect of fan motor heat. Units are suitable for operation in CFM range shown in airflow tables. Units are certified in accordance with the Unitary Air Conditioner Equipment certification program, which is based on ARI Standard 210/240 or 360.
- EER and/or SEER are rated at ARI conditions and in accordance with DOE test procedures.
- Heating Performance is rated at 47° F ambient, 70° F entering dry bulb for High Temp rating and 17° F ambient, 70° F entering dry bulb for Low Temp rating. Performance ratings do include the effect of fan motor heat.
- Outdoor Sound Rating shown is tested in accordance with ARI Standard 270.

GENERAL DATA - RQPM

NOMINAL SIZES 2-5 TONS [7-17.6 kW]

Model RQPM- Series	A042CK	A042JK	A048CK	A048JK
Cooling Performance¹				Continued ->
Gross Cooling Capacity Btu [kW]	44,000 [12.89]	44,000 [12.89]	49,000 [14.36]	49,000 [14.36]
EER/SEER ²	11.85/14	11.85/14	11.8/14	11.8/14
Nominal CFM/ARI Rated CFM [L/s]	1400/1450 [661/684]	1400/1450 [661/684]	1600/1550 [755/731]	1600/1550 [755/731]
ARI Net Cooling Capacity Btu [kW]	43,000 [12.6]	43,000 [12.6]	48,000 [14.06]	48,000 [14.06]
Net Sensible Capacity Btu [kW]	31,800 [9.32]	31,800 [9.32]	36,800 [10.78]	36,800 [10.78]
Net Latent Capacity Btu [kW]	11,200 [3.28]	11,200 [3.28]	11,200 [3.28]	11,200 [3.28]
Net System Power kW	3.63	3.63	4.1	4.1
Heating Performance (Heat Pumps)³				
High Temp. Btuh [kW] Rating	38,500 [11.28]	38,500 [11.28]	42,000 [12.31]	42,000 [12.31]
System Power KW / COP	3.31/3.4	3.31/3.4	3.59/3.66	3.59/3.66
Low Temp. Btuh [kW] Rating	21,800 [6.39]	21,800 [6.39]	25,400 [7.44]	25,400 [7.44]
System Power KW / COP	3/2.06	3/2.06	3.22/2.3	3.22/2.3
HSPF (Btu/Watts-hr)	8	8	8	8
Compressor				
No./Type	1/Copeland Scroll	1/Copeland Scroll	1/Copeland Scroll	1/Copeland Scroll
Outdoor Sound Rating (dB)⁴	78	78	78	78
Outdoor Coil - Fin Type	Louvered	Louvered	Louvered	Louvered
Tube Type	Rifled	Rifled	Rifled	Rifled
Tube Size in. [mm] OD	0.375 [9.5]	0.375 [9.5]	0.375 [9.5]	0.375 [9.5]
Face Area sq. ft. [sq. m]	16.54 [1.54]	16.54 [1.54]	16.54 [1.54]	16.54 [1.54]
Rows / FPI [FPcm]	1 / 22 [9]	1 / 22 [9]	1 / 22 [9]	1 / 22 [9]
Refrigerant Control	TX Valves	TX Valves	TX Valves	TX Valves
Indoor Coil - Fin Type	Louvered	Louvered	Louvered	Louvered
Tube Type	Rifled	Rifled	Rifled	Rifled
Tube Size in. [mm]	0.375 [9.5]	0.375 [9.5]	0.375 [9.5]	0.375 [9.5]
Face Area sq. ft. [sq. m]	5.78 [0.54]	5.78 [0.54]	5.78 [0.54]	5.78 [0.54]
Rows / FPI [FPcm]	3 / 13 [5]	3 / 13 [5]	3 / 13 [5]	3 / 13 [5]
Refrigerant Control	TX Valves	TX Valves	TX Valves	TX Valves
Drain Connection No./Size in. [mm]	1/1 [25.4]	1/1 [25.4]	1/1 [25.4]	1/1 [25.4]
Outdoor Fan - Type	Propeller	Propeller	Propeller	Propeller
No. Used/Diameter in. [mm]	1/24 [609.6]	1/24 [609.6]	1/24 [609.6]	1/24 [609.6]
Drive Type/No. Speeds	Direct/1	Direct/1	Direct/1	Direct/1
CFM [L/s]	4200 [1982]	4200 [1982]	4200 [1982]	4200 [1982]
No. Motors/HP	1 at 1/3 HP	1 at 1/3 HP	1 at 1/3 HP	1 at 1/3 HP
Motor RPM	1075	1075	1075	1075
Indoor Fan - Type	FC Centrifugal	FC Centrifugal	FC Centrifugal	FC Centrifugal
No. Used/Diameter in. [mm]	1/11x9 [279.4x228.6]	1/11x9 [279.4x228.6]	1/11x9 [279.4x228.6]	1/11x9 [279.4x228.6]
Drive Type/No. Speeds	Direct/2	Direct/2	Direct/2	Direct/2
No. Motors	1	1	1	1
Motor HP	3/4	3/4	3/4	3/4
Motor RPM	1050	1050	1050	1050
Motor Frame Size	48	48	48	48
Filter - Type	Field Supplied	Field Supplied	Field Supplied	Field Supplied
Furnished	No	No	No	No
(NO.) Size Recommended in. [mm x mm x mm]	(1)1x24x24 [25x610x610]	(1)1x24x24 [25x610x610]	(1)1x24x24 [25x610x610]	(1)1x24x24 [25x610x610]
Refrigerant Charge Oz. [g]	128 [3629]	128 [3629]	120 [3402]	120 [3402]
Weights				
Net Weight lbs. [kg]	408 [185]	408 [185]	429 [195]	429 [195]
Ship Weight lbs. [kg]	434 [197]	434 [197]	455 [206]	455 [206]

NOTES:

- Cooling Performance is rated at 95° F ambient, 80° F entering dry bulb, 67° F entering wet bulb. Gross capacity does not include the effect of fan motor heat. ARI capacity is net and includes the effect of fan motor heat. Units are suitable for operation in CFM range shown in airflow tables. Units are certified in accordance with the Unitary Air Conditioner Equipment certification program, which is based on ARI Standard 210/240 or 360.
- EER and/or SEER are rated at ARI conditions and in accordance with DOE test procedures.
- Heating Performance is rated at 47° F ambient, 70° F entering dry bulb for High Temp rating and 17° F ambient, 70° F entering dry bulb for Low Temp rating. Performance ratings do include the effect of fan motor heat.
- Outdoor Sound Rating shown is tested in accordance with ARI Standard 270.

GENERAL DATA - RQPM

NOMINAL SIZES 2-5 TONS [7-17.6 kW]

Model RQPM- Series	A060CK	A060JK
Cooling Performance¹		
Gross Cooling Capacity Btu [kW]	61,000 [17.87]	61,000 [17.87]
EER/SEER ²	11.9/14	11.9/14
Nominal CFM/ARI Rated CFM [L/s]	2000/1900 [944/897]	2000/1900 [944/897]
ARI Net Cooling Capacity Btu [kW]	59,500 [17.43]	59,500 [17.43]
Net Sensible Capacity Btu [kW]	45,300 [13.27]	45,300 [13.27]
Net Latent Capacity Btu [kW]	14,200 [4.16]	14,200 [4.16]
Net System Power kW	5	5
Heating Performance (Heat Pumps)³		
High Temp. Btuh [kW] Rating	59,500 [17.43]	59,500 [17.43]
System Power KW / COP	4.74/3.72	4.74/3.72
Low Temp. Btuh [kW] Rating	36,600 [10.72]	36,600 [10.72]
System Power KW / COP	4.26/2.54	4.26/2.54
HSPF (Btu/Watts-hr)	8	8
Compressor		
No./Type	1/Copeland Scroll	1/Copeland Scroll
Outdoor Sound Rating (dB)⁴		
	78	78
Outdoor Coil - Fin Type		
Tube Type	Louvered	Louvered
Tube Size in. [mm] OD	Rifled	Rifled
Face Area sq. ft. [sq. m]	0.375 [9.5]	0.375 [9.5]
Rows / FPI [FPcm]	16.54 [1.54]	16.54 [1.54]
Refrigerant Control	2 / 18 [7]	2 / 18 [7]
	TX Valves	TX Valves
Indoor Coil - Fin Type		
Tube Type	Louvered	Louvered
Tube Size in. [mm]	Rifled	Rifled
Face Area sq. ft. [sq. m]	0.375 [9.5]	0.375 [9.5]
Rows / FPI [FPcm]	5.78 [0.54]	5.78 [0.54]
Refrigerant Control	4 / 13 [5]	4 / 13 [5]
Drain Connection No./Size in. [mm]	TX Valves	TX Valves
	1/1 [25.4]	1/1 [25.4]
Outdoor Fan - Type		
No. Used/Diameter in. [mm]	Propeller	Propeller
Drive Type/No. Speeds	1/24 [609.6]	1/24 [609.6]
CFM [L/s]	Direct/1	Direct/1
No. Motors/HP	4000 [1888]	4000 [1888]
Motor RPM	1 at 1/3 HP	1 at 1/3 HP
	1075	1075
Indoor Fan - Type		
No. Used/Diameter in. [mm]	FC Centrifugal	FC Centrifugal
Drive Type/No. Speeds	1/11x9 [279.4x228.6]	1/11x9 [279.4x228.6]
No. Motors	Direct/2	Direct/2
Motor HP	1	1
Motor RPM	1	1
Motor Frame Size	1050	1050
	48	48
Filter - Type		
Furnished	Field Supplied	Field Supplied
(NO.) Size Recommended in. [mm x mm x mm]	No	No
	(1)1x24x24 [25x610x610]	(1)1x24x24 [25x610x610]
Refrigerant Charge Oz. [g]		
	193 [5472]	193 [5472]
Weights		
Net Weight lbs. [kg]	481 [218]	481 [218]
Ship Weight lbs. [kg]	507 [230]	507 [230]

NOTES:

- Cooling Performance is rated at 95° F ambient, 80° F entering dry bulb, 67° F entering wet bulb. Gross capacity does not include the effect of fan motor heat. ARI capacity is net and includes the effect of fan motor heat. Units are suitable for operation in CFM range shown in airflow tables. Units are certified in accordance with the Unitary Air Conditioner Equipment certification program, which is based on ARI Standard 210/240 or 360.
- EER and/or SEER are rated at ARI conditions and in accordance with DOE test procedures.
- Heating Performance is rated at 47° F ambient, 70° F entering dry bulb for High Temp rating and 17° F ambient, 70° F entering dry bulb for Low Temp rating. Performance ratings do include the effect of fan motor heat.
- Outdoor Sound Rating shown is tested in accordance with ARI Standard 270.

GENERAL DATA - RQNM

NOMINAL SIZES 2-5 TONS [7-17.6 kW]

Model RQNM- Series	A024JK	A030JK	A036CK	A036JK
Cooling Performance¹				Continued ->
Gross Cooling Capacity Btu [kW]	24,600 [7.21]	29,800 [8.73]	36,600 [10.72]	36,600 [10.72]
EER/SEER ²	11/13	11.15/13	11/13	11/13
Nominal CFM/ARI Rated CFM [L/s]	800/800 [378/378]	1000/1000 [472/472]	1200/1200 [566/566]	1200/1200 [566/566]
ARI Net Cooling Capacity Btu [kW]	23,600 [6.91]	28,800 [8.44]	35,200 [10.31]	35,200 [10.31]
Net Sensible Capacity Btu [kW]	18,200 [5.33]	22,400 [6.56]	27,000 [7.91]	27,000 [7.91]
Net Latent Capacity Btu [kW]	5,400 [1.58]	6,400 [1.88]	8,200 [2.4]	8,200 [2.4]
Net System Power kW	2.14	2.58	3.2	3.2
Heating Performance (Heat Pumps)³				
High Temp. Btuh [kW] Rating	23,400 [6.86]	28,800 [8.44]	35,000 [10.26]	35,000 [10.26]
System Power KW / COP	2.07/3.34	2.45/3.44	2.95/3.48	2.95/3.48
Low Temp. Btuh [kW] Rating	13,800 [4.04]	16,200 [4.75]	19,200 [5.63]	19,200 [5.63]
System Power KW / COP	1.91/2.12	2.22/2.14	2.65/2.1	2.65/2.1
HSPF (Btu/Watts-hr)	7.7	7.7	7.7	7.7
Compressor				
No./Type	1/Copeland Scroll	1/Copeland Scroll	1/Copeland Scroll	1/Copeland Scroll
Outdoor Sound Rating (dB)⁴	76	76	76	76
Outdoor Coil - Fin Type	Louvered	Louvered	Louvered	Louvered
Tube Type	Rifled	Rifled	Rifled	Rifled
Tube Size in. [mm] OD	0.375 [9.5]	0.375 [9.5]	0.375 [9.5]	0.375 [9.5]
Face Area sq. ft. [sq. m]	10.44 [0.97]	12.65 [1.18]	12.65 [1.18]	12.65 [1.18]
Rows / FPI [FPcm]	1 / 20 [8]	1 / 20 [8]	1 / 20 [8]	1 / 20 [8]
Refrigerant Control	TX Valves	TX Valves	TX Valves	TX Valves
Indoor Coil - Fin Type	Louvered	Louvered	Louvered	Louvered
Tube Type	Rifled	Rifled	Rifled	Rifled
Tube Size in. [mm]	0.375 [9.5]	0.375 [9.5]	0.375 [9.5]	0.375 [9.5]
Face Area sq. ft. [sq. m]	4.33 [0.4]	4.33 [0.4]	4.33 [0.4]	4.33 [0.4]
Rows / FPI [FPcm]	2 / 15 [5]	3 / 13 [6]	3 / 13 [5]	3 / 13 [5]
Refrigerant Control	TX Valves	TX Valves	TX Valves	TX Valves
Drain Connection No./Size in. [mm]	1/1 [25.4]	1/1 [25.4]	1/1 [25.4]	1/1 [25.4]
Outdoor Fan - Type	Propeller	Propeller	Propeller	Propeller
No. Used/Diameter in. [mm]	1/24 [609.6]	1/24 [609.6]	1/24 [609.6]	1/24 [609.6]
Drive Type/No. Speeds	Direct/1	Direct/1	Direct/1	Direct/1
CFM [L/s]	3200 [1510]	3200 [1510]	3200 [1510]	3200 [1510]
No. Motors/HP	1 at 1/3 HP	1 at 1/3 HP	1 at 1/3 HP	1 at 1/3 HP
Motor RPM	825	825	825	825
Indoor Fan - Type	FC Centrifugal	FC Centrifugal	FC Centrifugal	FC Centrifugal
No. Used/Diameter in. [mm]	1/10x9 [254x228.6]	1/10x9 [254x228.6]	1/10x9 [254x228.6]	1/10x9 [254x228.6]
Drive Type/No. Speeds	Direct/2	Direct/2	Direct/2	Direct/2
No. Motors	1	1	1	1
Motor HP	1/4	1/3	1/2	1/2
Motor RPM	1033	1080	1050	1050
Motor Frame Size	48	48	48	48
Filter - Type	Field Supplied	Field Supplied	Field Supplied	Field Supplied
Furnished	No	No	No	No
(NO.) Size Recommended in. [mm x mm x mm]	(1)1x20x16 [25x508x406]	(1)1x20x20 [25x508x508]	(1)1x24x24 [25x610x610]	(1)1x24x24 [25x610x610]
Refrigerant Charge Oz. [g]	90 [2552]	93 [2637]	93 [2637]	93 [2637]
Weights				
Net Weight lbs. [kg]	308 [140]	331 [150]	356 [161]	356 [161]
Ship Weight lbs. [kg]	332 [151]	355 [161]	380 [172]	380 [172]

NOTES:

- Cooling Performance is rated at 95° F ambient, 80° F entering dry bulb, 67° F entering wet bulb. Gross capacity does not include the effect of fan motor heat. ARI capacity is net and includes the effect of fan motor heat. Units are suitable for operation in CFM range shown in airflow tables. Units are certified in accordance with the Unitary Air Conditioner Equipment certification program, which is based on ARI Standard 210/240 or 360.
- EER and/or SEER are rated at ARI conditions and in accordance with DOE test procedures.
- Heating Performance is rated at 47° F ambient, 70° F entering dry bulb for High Temp rating and 17° F ambient, 70° F entering dry bulb for Low Temp rating. Performance ratings do include the effect of fan motor heat.
- Outdoor Sound Rating shown is tested in accordance with ARI Standard 270.

GENERAL DATA - RQNM

NOMINAL SIZES 2-5 TONS [7-17.6 kW]

Model RQNM- Series	A042CK	A042JK	A048CK	A048JK
Cooling Performance¹				Continued ->
Gross Cooling Capacity Btu [kW]	43,500 [12.75]	43,500 [12.75]	49,500 [14.5]	49,500 [14.5]
EER/SEER ²	11/13	11/13	11/13	11/13
Nominal CFM/ARI Rated CFM [L/s]	1400/1450 [661/684]	1400/1450 [661/684]	1600/1550 [755/731]	1600/1550 [755/731]
ARI Net Cooling Capacity Btu [kW]	42,000 [12.31]	42,000 [12.31]	47,500 [13.92]	47,500 [13.92]
Net Sensible Capacity Btu [kW]	30,000 [8.79]	30,000 [8.79]	35,900 [10.52]	35,900 [10.52]
Net Latent Capacity Btu [kW]	12,000 [3.52]	12,000 [3.52]	11,600 [3.4]	11,600 [3.4]
Net System Power kW	3.82	3.82	4.32	4.32
Heating Performance (Heat Pumps)³				
High Temp. Btuh [kW] Rating	39,500 [11.57]	39,500 [11.57]	43,000 [12.6]	43,000 [12.6]
System Power KW / COP	3.56/3.24	3.56/3.24	3.92/3.44	3.92/3.44
Low Temp. Btuh [kW] Rating	22,800 [6.68]	22,800 [6.68]	25,600 [7.5]	25,600 [7.5]
System Power KW / COP	3.25/2.06	3.25/2.06	3.56/2.14	3.56/2.14
HSPF (Btu/Watts-hr)	7.7	7.7	7.7	7.7
Compressor				
No./Type	1/Copeland Scroll	1/Copeland Scroll	1/Copeland Scroll	1/Copeland Scroll
Outdoor Sound Rating (dB)⁴	78	78	78	78
Outdoor Coil - Fin Type	Louvered	Louvered	Louvered	Louvered
Tube Type	Rifled	Rifled	Rifled	Rifled
Tube Size in. [mm] OD	0.375 [9.5]	0.375 [9.5]	0.375 [9.5]	0.375 [9.5]
Face Area sq. ft. [sq. m]	16.54 [1.54]	16.54 [1.54]	16.54 [1.54]	16.54 [1.54]
Rows / FPI [FPcm]	1 / 22 [9]	1 / 22 [9]	1 / 22 [9]	1 / 22 [9]
Refrigerant Control	TX Valves	TX Valves	TX Valves	TX Valves
Indoor Coil - Fin Type	Louvered	Louvered	Louvered	Louvered
Tube Type	Rifled	Rifled	Rifled	Rifled
Tube Size in. [mm]	0.375 [9.5]	0.375 [9.5]	0.375 [9.5]	0.375 [9.5]
Face Area sq. ft. [sq. m]	5.78 [0.54]	5.78 [0.54]	5.78 [0.54]	5.78 [0.54]
Rows / FPI [FPcm]	3 / 13 [5]	3 / 13 [5]	3 / 13 [5]	3 / 13 [5]
Refrigerant Control	TX Valves	TX Valves	TX Valves	TX Valves
Drain Connection No./Size in. [mm]	1/1 [25.4]	1/1 [25.4]	1/1 [25.4]	1/1 [25.4]
Outdoor Fan - Type	Propeller	Propeller	Propeller	Propeller
No. Used/Diameter in. [mm]	1/24 [609.6]	1/24 [609.6]	1/24 [609.6]	1/24 [609.6]
Drive Type/No. Speeds	Direct/1	Direct/1	Direct/1	Direct/1
CFM [L/s]	4200 [1982]	4200 [1982]	4200 [1982]	4200 [1982]
No. Motors/HP	1 at 1/3 HP	1 at 1/3 HP	1 at 1/3 HP	1 at 1/3 HP
Motor RPM	1075	1075	1075	1075
Indoor Fan - Type	FC Centrifugal	FC Centrifugal	FC Centrifugal	FC Centrifugal
No. Used/Diameter in. [mm]	1/11x9 [279.4x228.6]	1/11x9 [279.4x228.6]	1/11x9 [279.4x228.6]	1/11x9 [279.4x228.6]
Drive Type/No. Speeds	Direct/2	Direct/2	Direct/2	Direct/2
No. Motors	1	1	1	1
Motor HP	1/2	1/2	3/4	3/4
Motor RPM	1075	1075	1075	1075
Motor Frame Size	48	48	48	48
Filter - Type	Field Supplied	Field Supplied	Field Supplied	Field Supplied
Furnished	No	No	No	No
(NO.) Size Recommended in. [mm x mm x mm]	(1)1x24x24 [25x610x610]	(1)1x24x24 [25x610x610]	(1)1x24x24 [25x610x610]	(1)1x24x24 [25x610x610]
Refrigerant Charge Oz. [g]	128 [3629]	128 [3629]	120 [3402]	120 [3402]
Weights				
Net Weight lbs. [kg]	408 [185]	408 [185]	429 [195]	429 [195]
Ship Weight lbs. [kg]	434 [197]	434 [197]	455 [206]	455 [206]

NOTES:

- Cooling Performance is rated at 95° F ambient, 80° F entering dry bulb, 67° F entering wet bulb. Gross capacity does not include the effect of fan motor heat. ARI capacity is net and includes the effect of fan motor heat. Units are suitable for operation in CFM range shown in airflow tables. Units are certified in accordance with the Unitary Air Conditioner Equipment certification program, which is based on ARI Standard 210/240 or 360.
- EER and/or SEER are rated at ARI conditions and in accordance with DOE test procedures.
- Heating Performance is rated at 47° F ambient, 70° F entering dry bulb for High Temp rating and 17° F ambient, 70° F entering dry bulb for Low Temp rating. Performance ratings do include the effect of fan motor heat.
- Outdoor Sound Rating shown is tested in accordance with ARI Standard 270.

GENERAL DATA - RQNM

NOMINAL SIZES 2-5 TONS [7-17.6 kW]

Model RQNM- Series	A060CK	A060JK
Cooling Performance¹		
Gross Cooling Capacity Btu [kW]	62,000 [18.17]	62,000 [18.17]
EER/SEER ²	11/13	11/13
Nominal CFM/ARI Rated CFM [L/s]	2000/1900 [944/897]	2000/1900 [944/897]
ARI Net Cooling Capacity Btu [kW]	59,000 [17.29]	59,000 [17.29]
Net Sensible Capacity Btu [kW]	44,500 [13.04]	44,500 [13.04]
Net Latent Capacity Btu [kW]	14,500 [4.25]	14,500 [4.25]
Net System Power kW	5.36	5.36
Heating Performance (Heat Pumps)³		
High Temp. Btuh [kW] Rating	61,000 [17.87]	61,000 [17.87]
System Power KW / COP	5.15/3.52	5.15/3.52
Low Temp. Btuh [kW] Rating	34,400 [10.08]	34,400 [10.08]
System Power KW / COP	4.64/2.18	4.64/2.18
HSPF (Btu/Watts-hr)	7.7	7.7
Compressor		
No./Type	1/Copeland Scroll	1/Copeland Scroll
Outdoor Sound Rating (dB)⁴		
	78	78
Outdoor Coil - Fin Type		
Tube Type	Louvered	Louvered
Tube Size in. [mm] OD	Rifled	Rifled
Face Area sq. ft. [sq. m]	0.375 [9.5]	0.375 [9.5]
Rows / FPI [FPcm]	16.54 [1.54]	16.54 [1.54]
Refrigerant Control	2 / 18 [7]	2 / 18 [7]
	TX Valves	TX Valves
Indoor Coil - Fin Type		
Tube Type	Louvered	Louvered
Tube Size in. [mm]	Rifled	Rifled
Face Area sq. ft. [sq. m]	0.375 [9.5]	0.375 [9.5]
Rows / FPI [FPcm]	5.78 [0.54]	5.78 [0.54]
Refrigerant Control	4 / 13 [5]	4 / 13 [5]
Drain Connection No./Size in. [mm]	TX Valves	TX Valves
	1/1 [25.4]	1/1 [25.4]
Outdoor Fan - Type		
No. Used/Diameter in. [mm]	Propeller	Propeller
Drive Type/No. Speeds	1/24 [609.6]	1/24 [609.6]
CFM [L/s]	Direct/1	Direct/1
No. Motors/HP	4000 [1888]	4000 [1888]
Motor RPM	1 at 1/3 HP	1 at 1/3 HP
	1075	1075
Indoor Fan - Type		
No. Used/Diameter in. [mm]	FC Centrifugal	FC Centrifugal
Drive Type/No. Speeds	1/11x9 [279.4x228.6]	1/11x9 [279.4x228.6]
No. Motors	Direct/2	Direct/2
Motor HP	1	1
Motor RPM	3/4	3/4
Motor Frame Size	1075	1075
	48	48
Filter - Type		
Furnished	Field Supplied	Field Supplied
(NO.) Size Recommended in. [mm x mm x mm]	No	No
	(1)1x24x24 [25x610x610]	(1)1x24x24 [25x610x610]
Refrigerant Charge Oz. [g]		
	193 [5472]	193 [5472]
Weights		
Net Weight lbs. [kg]	481 [218]	481 [218]
Ship Weight lbs. [kg]	507 [230]	507 [230]

NOTES:

- Cooling Performance is rated at 95° F ambient, 80° F entering dry bulb, 67° F entering wet bulb. Gross capacity does not include the effect of fan motor heat. ARI capacity is net and includes the effect of fan motor heat. Units are suitable for operation in CFM range shown in airflow tables. Units are certified in accordance with the Unitary Air Conditioner Equipment certification program, which is based on ARI Standard 210/240 or 360.
- EER and/or SEER are rated at ARI conditions and in accordance with DOE test procedures.
- Heating Performance is rated at 47° F ambient, 70° F entering dry bulb for High Temp rating and 17° F ambient, 70° F entering dry bulb for Low Temp rating. Performance ratings do include the effect of fan motor heat.
- Outdoor Sound Rating shown is tested in accordance with ARI Standard 270.

XIX. MISCELLANEOUS

ELECTRICAL AND PHYSICAL DATA

ELECTRICAL DATA - RQPM SERIES											
		-A024JK	-A030JK	-A036CK	-A036JK	-A042CK	-A042JK	-A048CK	-A048JK	-A060CK	-A060JK
Unit Information	Unit Operating Voltage Range	187-253	187-253	187-253	187-253	187-253	187-253	187-253	187-253	187-253	187-253
	Minimum Circuit Ampacity	23/23	21/21	19/19	27/27	26/26	36/36	26/26	36/36	32/32	43/43
	Minimum Overcurrent Protection Device Size	30/30	30/30	25/25	35/35	30/30	45/45	30/30	45/45	40/40	50/50
	Maximum Overcurrent Protection Device Size	35/35	35/35	25/25	40/40	35/35	50/50	35/35	50/50	45/45	60/60
Compressor Motor	No.	1	1	1	1	1	1	1	1	1	1
	Volts	208/230	208/230	208/230	208/230	208/230	208/230	208/230	208/230	208/230	208/230
	Phase	1	1	3	1	3	1	3	1	3	1
	HP	2	2.5	3	3	3.5	3.5	4	4	4.5	4.5
	RPM	3450	3450	3450	3450	3450	3450	3450	3450	3450	3450
	Amps (RLA)	13.5/13.5	14.1/14.1	10.4/10.4	16.7/16.7	14.1/14.1	21.8/21.8	13.7/13.7	21.8/21.8	17.9/17.9	26.4/26.4
	Amps (LRA)	58.3/58.3	73/73	88/88	79/79	95/95	112/112	110/110	117/117	120/120	150/150
Condenser Motor	No.	1	1	1	1	1	1	1	1	1	1
	Volts	208/230	208/230	208/230	208/230	208/230	208/230	208/230	208/230	208/230	208/230
	Phase	1	1	1	1	1	1	1	1	1	1
	HP	1/3	1/3	1/3	1/3	1/3	1/3	1/3	1/3	1/3	1/3
	Amps (FLA)	1.5	1.5	1.5	1.5	1.9	1.9	1.9	1.9	1.9	1.9
	Amps (LRA)	3	3	3	3	4	4	4	4	4	4
Evaporator Fan	No.	1	1	1	1	1	1	1	1	1	1
	Volts	208/230	208/230	208/230	208/230	208/230	208/230	208/230	208/230	208/230	208/230
	Phase	1	1	1	1	1	1	1	1	1	1
	HP	1/2	1/2	1/2	1/2	3/4	3/4	3/4	3/4	1	1
	Amps (FLA)	4.1	4.1	4.1	4.1	6	6	6	6	7.6	7.6

ELECTRICAL AND PHYSICAL DATA

ELECTRICAL DATA - RQNM SERIES											
		-A024JK	-A030JK	-A036CK	-A036JK	-A042CK	-A042JK	-A048CK	-A048JK	-A060CK	-A060JK
Unit Information	Unit Operating Voltage Range	187-253	187-253	187-253	187-253	187-253	187-253	187-253	187-253	187-253	187-253
	Minimum Circuit Ampacity	20/20	21/21	17/17	25/25	23/23	33/33	23/23	33/33	31/31	41/41
	Minimum Overcurrent Protection Device Size	25/25	25/25	20/20	30/30	30/30	40/40	30/30	40/40	35/35	50/50
	Maximum Overcurrent Protection Device Size	30/30	35/35	25/25	40/40	35/35	50/50	35/35	50/50	45/45	60/60
Compressor Motor	No.	1	1	1	1	1	1	1	1	1	1
	Volts	208/230	208/230	208/230	208/230	208/230	208/230	208/230	208/230	208/230	208/230
	Phase	1	1	3	1	3	1	3	1	3	1
	HP	2	2.5	3	3	3.5	3.5	4	4	4.5	4.5
	RPM	3450	3450	3450	3450	3450	3450	3450	3450	3450	3450
	Amps (RLA)	13.5/13.5	14.1/14.1	10.4/10.4	16.7/16.7	14.1/14.1	21.8/21.8	13.7/13.7	21.8/21.8	17.9/17.9	26.4/26.4
	Amps (LRA)	58.3/58.3	73/73	88/88	79/79	95/95	112/112	83.1/83.1	117/117	120/120	150/150
Condenser Motor	No.	1	1	1	1	1	1	1	1	1	1
	Volts	208/230	208/230	208/230	208/230	208/230	208/230	208/230	208/230	208/230	208/230
	Phase	1	1	1	1	1	1	1	1	1	1
	HP	1/3	1/3	1/3	1/3	1/3	1/3	1/3	1/3	1/3	1/3
	Amps (FLA)	1.5	1.5	1.5	1.5	1.9	1.9	1.9	1.9	1.9	1.9
	Amps (LRA)	3	3	3	3	4	4	4	4	4	4
Evaporator Fan	No.	1	1	1	1	1	1	1	1	1	1
	Volts	208/230	208/230	208/230	208/230	208/230	208/230	208/230	208/230	208/230	208/230
	Phase	1	1	1	1	1	1	1	1	1	1
	HP	1/4	1/3	1/2	1/2	1/2	1/2	3/4	3/4	3/4	3/4
	Amps (FLA)	1.5	1.7	2.5	2.5	2.7	2.7	3.2	3.2	5.8	5.8
	Amps (LRA)	2.6	2.6	5	5	4.6	4.6	4.4	4.4	11.3	11.3

INDOOR AIRFLOW PERFORMANCE FOR 2-5 TON PACKAGE HEAT PUMPS – 230V RQPM SERIES

Nominal Cooling Capacity Tons	Motor Speed From Factory	Manufacturer Recommended Air-Flow Range (Min / Max) CFM	Blower Size/ Motor HP # of Speeds	Motor Speed	CFM Air Delivery/RPM/Watts-230 Volts										
					External Static Pressure-Inches W.C.										
					0.10	0.20	0.30	0.40	0.50	0.60	0.70	0.80	0.90	1.00	
2.0	Low (Tap 2)	700 / 900	10x9 1/4 2 Speed (X-13 Motor)	Low (Tap 2)	CFM	939	877	816	754	693	631	570	508	447	
					RPM	585	601	655	744	809	860	915	1001	1043	
					Watts	131	116	97	110	121	126	136	149	152	
	High (Tap 1)	700 / 900	10x9 1/4 2 Speed (X-13 Motor)	High (Tap 1)	CFM	1240	1184	1127	1071	1014	958	901	845	788	732
					RPM	607	634	698	761	815	880	946	989	1038	1091
					Watts	161	145	159	173	182	196	210	220	231	237
2.5	Low (Tap 2)	875 / 1125	10x9 1/3 2 Speed (X-13 Motor)	Low (Tap 2)	CFM	1169	1109	1049	988	928	868	807	747	687	626
					RPM	603	619	693	756	809	893	942	989	1034	1076
					Watts	144	130	138	151	159	174	185	195	199	209
	High (Tap 1)	875 / 1125	10x9 1/3 2 Speed (X-13 Motor)	High (Tap 1)	CFM	1365	1316	1266	1217	1168	1119	1069	1020	971	922
					RPM	631	677	732	784	843	894	942	1035	1077	1118
					Watts	177	190	204	218	234	247	256	279	289	294
3.0	Low (Tap 2)	1050 / 1350	10x9 1/2 2 Speed (X-13 Motor)	Low (Tap 2)	CFM	1328	1280	1231	1183	1135	1086	1038	990	941	893
					RPM	648	697	752	807	857	903	989	1036	1077	1114
					Watts	178	191	206	220	233	246	265	277	286	291
	High (Tap 1)	1050 / 1350	10x9 1/2 2 Speed (X-13 Motor)	High (Tap 1)	CFM	1510	1464	1418	1373	1327	1281	1235	1190	1144	1098
					RPM	707	743	792	841	890	942	1031	1031	1114	1151
					Watts	248	261	277	292	307	322	334	348	366	358
3.5	Low (Tap 2)	1225 / 1575	11x9 1/2 2 Speed (X-13 Motor)	Low (Tap 2)	CFM	1542	1490	1438	1386	1335	1283	1231	1180	1128	1076
					RPM	598	617	662	714	758	800	849	876	913	951
					Watts	244	231	237	254	270	285	304	313	326	340
	High (Tap 1)	1225 / 1575	11x9 1/2 2 Speed (X-13 Motor)	High (Tap 1)	CFM	1740	1695	1649	1604	1558	1513	1467	1422	1376	1331
					RPM	632	665	709	749	797	833	879	917	951	981
					Watts	295	311	331	350	371	386	409	426	440	454
4.0	Low (Tap 2)	1400 / 1800	11x9 3/4 2 Speed (X-13 Motor)	Low (Tap 2)	CFM	1701	1655	1609	1563	1517	1471	1425	1379	1333	1287
					RPM	624	648	696	743	787	826	863	895	934	970
					Watts	280	287	309	328	347	363	380	392	410	426
	High (Tap 1)	1400 / 1800	11x9 3/4 2 Speed (X-13 Motor)	High (Tap 1)	CFM	1921	1878	1835	1792	1749	1706	1663	1620	1577	1534
					RPM	678	706	738	776	816	865	899	932	967	994
					Watts	385	400	416	439	458	484	501	517	537	550
5.0	Low (Tap 2)	1750 / 2250	11x9 3/4 2 Speed (X-13 Motor)	Low (Tap 2)	CFM	1986	1945	1905	1864	1823	1782	1741	1700	1659	1618
					RPM	731	759	792	832	871	909	943	979	1014	1055
					Watts	446	458	477	499	521	543	562	582	600	621
	High (Tap 1)	1750 / 2250	11x9 3/4 2 Speed (X-13 Motor)	High (Tap 1)	CFM	2229	2190	2152	2114	2075	2037	1999	1960	1922	1884
					RPM	795	824	851	882	919	952	983	1013	1045	1077
					Watts	619	638	658	680	703	724	745	764	784	804

INDOOR AIRFLOW PERFORMANCE FOR 2-5 TON PACKAGE HEAT PUMPS – 208V RQPM SERIES

Nominal Cooling Capacity Tons	Motor Speed From Factory	Manufacturer Recommended Flow Range (Min / Max) CFM	Blower Size/ Motor HP # of Speeds	Motor Speed	CFM Air Delivery/RPM/Watts-208 Volts												
					External Static Pressure-Inches W.C.												
					0.10	0.20	0.30	0.40	0.50	0.60	0.70	0.80	0.90	1.00			
2.0	Low (Tap 2)	700 / 900	10x9 1/4 2 Speed (X-13 Motor)	Low (Tap 2)	CFM	959	892	825	758	691	624	557	491				
				RPM	582	606	655	723	808	851	906	996					
				Watts	132	110	96	106	119	123	132	144					
2.5	Low (Tap 2)	875 / 1125	10x9 1/3 2 Speed (X-13 Motor)	High (Tap 1)	CFM	1229	1170	1112	1054	996	938	879	821	763	705		
				RPM	607	634	698	761	815	880	946	989	1038	1091			
				Watts	161	145	159	173	182	196	210	220	231	237			
2.5	Low (Tap 2)	875 / 1125	10x9 1/3 2 Speed (X-13 Motor)	Low (Tap 2)	CFM	1162	1099	1035	972	908	844	781	717	654	590		
				RPM	603	626	690	752	815	906	941	984	1027	1096			
				Watts	143	124	136	148	157	175	180	188	192	202			
2.5	Low (Tap 2)	875 / 1125	10x9 1/3 2 Speed (X-13 Motor)	High (Tap 1)	CFM	1306	1253	1200	1147	1095	1042	989	937	884	831		
				RPM	632	679	733	787	841	883	941	1035	1067	1099			
				Watts	174	187	201	215	227	235	248	266	273	277			
3.0	Low (Tap 2)	1050 / 1350	10x9 1/2 2 Speed (X-13 Motor)	Low (Tap 2)	CFM	1328	1276	1223	1171	1118	1066	1013	961				
				RPM	642	693	747	803	852	903	988	1031					
				Watts	173	187	200	214	226	238	254	263					
3.0	Low (Tap 2)	1050 / 1350	10x9 1/2 2 Speed (X-13 Motor)	High (Tap 1)	CFM	1508	1459	1409	1359	1310	1260	1210	1160	1111	1061		
				RPM	698	738	789	839	888	933	983	1035	1103	1137			
				Watts	243	255	271	285	299	310	322	332	343	343			
3.5	Low (Tap 2)	1225 / 1575	11x9 1/2 2 Speed (X-13 Motor)	Low (Tap 2)	CFM	1531	1477	1423	1370	1316	1262	1208	1154	1101	1047		
				RPM	602	619	668	715	757	801	844	878	918	954			
				Watts	238	227	236	251	266	281	296	307	320	333			
3.5	Low (Tap 2)	1225 / 1575	11x9 1/2 2 Speed (X-13 Motor)	High (Tap 1)	CFM	1724	1678	1632	1586	1540	1495	1449	1403	1357	1311		
				RPM	639	671	715	759	794	834	875	911	948	977			
				Watts	295	309	330	348	363	380	397	414	429	440			
4.0	Low (Tap 2)	1400 / 1800	11x9 3/4 2 Speed (X-13 Motor)	Low (Tap 2)	CFM	1708	1658	1609	1559	1510	1460	1410	1361	1311	1262		
				RPM	619	651	686	741	783	822	859	894	937	971			
				Watts	280	284	298	323	339	355	370	385	402	415			
4.0	Low (Tap 2)	1400 / 1800	11x9 3/4 2 Speed (X-13 Motor)	High (Tap 1)	CFM	1917	1872	1827	1782	1736	1691	1646	1601	1556	1510		
				RPM	673	702	736	769	818	860	898	928	960	989			
				Watts	377	392	409	426	451	473	490	504	518	531			
5.0	Low (Tap 2)	1750 / 2250	11x9 3/4 2 Speed (X-13 Motor)	Low (Tap 2)	CFM	1954	1914	1874	1833	1793	1753	1713	1673	1632	1592		
				RPM	719	747	779	818	857	894	928	963	998	1038			
				Watts	439	451	469	491	512	534	553	573	590	611			
5.0	Low (Tap 2)	1750 / 2250	11x9 3/4 2 Speed (X-13 Motor)	High (Tap 1)	CFM	2173	2136	2098	2061	2024	1986	1949	1911	1874	1837		
				RPM	775	803	830	860	896	928	959	988	1019	1050			
				Watts	604	622	642	663	686	706	727	745	765	784			

INDOOR AIRFLOW PERFORMANCE FOR 2-5 TON PACKAGE HEAT PUMPS – 230V RQNM SERIES

Nominal Cooling Capacity Tons	Motor Speed From Factory	Manufacturer Recommended Air-Flow Range (Min / Max) CFM	Blower Size/ Motor HP # of Speeds	Motor Speed	CFM Air Delivery/RPM/Watts-230 Volts										
					External Static Pressure-Inches W.C.										
					0.10	0.20	0.30	0.40	0.50	0.60	0.70	0.80	0.90	1.00	
2.0	Low	700 / 900	10x9 1/4 2 Speed (PSC Motor)	Low	CFM	827	811	782	740	684	614	531	435		
					RPM	450	533	626	742	799	894	932	985		
					Watts	278	273	269	254	244	227	216	198		
2.5	Low	875 / 1125	10x9 1/3 2 Speed (PSC Motor)	Low	CFM	1230	1223	1216	1211	1187	1125	1020	874	696	504
					RPM	575	643	703	767	819	877	976	1001	1072	1092
					Watts	479	468	455	448	431	416	357	341	279	259
2.5	Low	875 / 1125	10x9 1/3 2 Speed (PSC Motor)	Low	CFM	1032	1030	1014	979	923	843	735	596	423	
					RPM	533	570	659	746	795	863	934	1019	1050	
					Watts	336	331	326	314	303	280	271	227	210	
2.5	Low	875 / 1125	10x9 1/3 2 Speed (PSC Motor)	High	CFM	1312	1301	1292	1276	1246	1196	1117	1003	845	
					RPM	592	646	712	768	824	883	933	1012	1035	
					Watts	482	473	466	454	433	421	401	349	329	
3.0	Low	1050 / 1350	10x9 1/2 2 Speed (PSC Motor)	Low	CFM	1261	1253	1225	1177	1110	1023	915	788	641	
					RPM	648	705	754	802	854	896	985	1008	1041	
					Watts	398	395	387	391	370	361	323	310	300	
3.0	Low	1050 / 1350	10x9 1/2 2 Speed (PSC Motor)	High	CFM	2068	2008	1957	1905	1841	1753	1629	1458	1228	929
					RPM	850	883	917	946	972	999	1028	1049	1091	1108
					Watts	826	806	784	762	734	702	658	626	546	512
3.5	Low	1225 / 1575	11x9 1/2 2 Speed (PSC Motor)	Low	CFM	1431	1394	1348	1302	1258	1208	1140	1030	849	557
					RPM	540	579	633	686	724	776	831	868	1035	1076
					Watts	482	479	477	470	459	453	437	423	335	292
3.5	Low	1225 / 1575	11x9 1/2 2 Speed (PSC Motor)	High	CFM	1960	1936	1903	1859	1806	1742	1669	1585	1491	1387
					RPM	703	727	750	780	809	846	877	910	940	975
					Watts	783	782	776	759	750	729	712	686	656	625
4.0	Low	1400 / 1800	11x9 3/4 2 Speed (PSC Motor)	Low	CFM	1674	1638	1595	1547	1492	1432	1365	1293	1214	1129.1
					RPM	576	618	668	708	753	789	832	874	915	954
					Watts	575	563	556	549	544	532	522	503	483	465
4.0	Low	1400 / 1800	11x9 3/4 2 Speed (PSC Motor)	High	CFM	1996	1976	1947	1909	1863	1808	1744	1671	1590	1500
					RPM	680	722	752	781	807	833	867	912	936	973
					Watts	799	787	784	760	753	749	730	699	693	652
5.0	Low	1750 / 2250	11x9 3/4 2 Speed (PSC Motor)	Low	CFM	2044	2017	1983	1941	1892	1836	1773	1702	1623	1537
					RPM	689	723	756	798	822	855	889	924	951	988
					Watts	886	870	865	849	831	817	799	782	755	726
5.0	Low	1750 / 2250	11x9 3/4 2 Speed (PSC Motor)	High	CFM	2693	2654	2606	2549	2483	2408	2323	2230	2127	2015
					RPM	876	897	915	938	956	975	996	1009	1025	1044
					Watts	1438	1427	1399	1368	1340	1312	1274	1228	1192	1146

ELECTRIC HEATER KIT - 1 PHASE RQNM

208-240 VOLT, SINGLE PHASE, 60 HZ, AUXILIARY ELECTRIC HEATER KITS CHARACTERISTICS AND APPLICATION												
Model No. RQNM-	Single Power Supply For Both Unit And Heater Kit						Separate Power Supply For Both Unit And Heater Kit					
	RXQJ-Heater Kit Nominal kW	No. of Elements	No. of Sequence Steps	Rated Heater kW @ 208-240 V	Heater KBTU/Hr @ 208-240 V	Heater Amp. @ 208-240 V	Unit Min. Ckt Ampacity @ 208-240 V	Over Current Protective Device Size Min/Max @ 208 V	Heater Kit Min. Ckt. Ampacity	Heater Kit Max. Fuse Size	Heat Pump Min. Ckt. Ampacity 208	Heat Pump Over Current Protective Device Size Min/Max @ 208 V
A024J	No Heat	-	-	-	-	-	20/20	25/30	-	-	20/20	25/30
	C05J	1	1	3.6/4.8	12.28/16.38	17.33/20	42/45	45/50	22/25	25/25	-	-
	C07J	1	1	5.4/7.2	18.42/24.56	26/30	53/58	60/60	33/38	35/40	-	-
	C10J	2	1	7.2/9.6	24.57/32.76	34.7/40	64/70	70/70	44/50	45/50	-	-
A030J	No Heat	-	-	-	-	-	21/21	25/35	-	-	21/21	25/35
	C05J	1	1	3.6/4.8	12.28/16.38	17.33/20	43/46	45/50	22/25	25/25	-	-
	C07J	1	1	5.4/7.2	18.42/24.56	26/30	54/59	60/60	33/38	35/40	-	-
	C10J	2	1	7.2/9.6	24.57/32.76	34.7/40	65/71	70/70	44/50	45/50	-	-
	C15J	3	2	10.8/14.4	36.85/49.13	52/60	86/96	90/90	65/75	70/80	-	-
	No Heat	-	-	-	-	-	25/25	30/40	-	-	25/25	30/40
A036J	C05J	1	1	3.6/4.8	12.28/16.38	17.33/20	47/50	50/50	22/25	25/25	-	-
	C07J	1	1	5.4/7.2	18.42/24.56	26/30	58/63	60/60	33/38	35/40	-	-
	C10J	2	1	7.2/9.6	24.57/32.76	34.7/40	69/75	70/70	44/50	45/50	-	-
	C15J	3	2	10.8/14.4	36.85/49.13	52/60	90/100	90/90	65/75	70/80	-	-
	C20J	4	2	14.4/19.2	49.12/65.52	69.33/80	112/125	125/125	87/100	90/100	-	-
	No Heat	-	-	-	-	-	33/33	40/50	-	-	33/33	40/50
A042J	C05J	1	1	3.6/4.8	12.28/16.38	17.33/20	54/58	60/70	22/25	25/25	-	-
	C07J	1	1	5.4/7.2	18.42/24.56	26/30	65/70	70/70	33/38	35/40	-	-
	C10J	2	1	7.2/9.6	24.57/32.76	34.7/40	76/83	80/80	44/50	45/50	-	-
	C15J	3	2	10.8/14.4	36.85/49.13	52/60	98/108	100/100	65/75	70/80	-	-
	C20J	4	2	14.4/19.2	49.12/65.52	69.33/80	112/133	125/125	87/100	90/100	-	-
	No Heat	-	-	-	-	-	33/33	40/50	-	-	33/33	40/50
A048J	C05J	1	1	3.6/4.8	12.28/16.38	17.33/20	55/58	60/70	22/25	25/25	-	-
	C07J	1	1	5.4/7.2	18.42/24.56	26/30	65/70	70/80	33/38	35/40	-	-
	C10J	2	1	7.2/9.6	24.57/32.76	34.7/40	76/83	80/80	44/50	45/50	-	-
	C15J	3	2	10.8/14.4	36.85/49.13	52/60	98/108	100/100	65/75	70/80	-	-
	C20J	4	2	14.4/19.2	49.12/65.52	69.33/80	120/133	125/125	87/100	90/100	-	-
	No Heat	-	-	-	-	-	41/41	50/60	-	-	41/41	50/60
A060J	C05J	1	1	3.6/4.8	12.28/16.38	17.33/20	63/66	80/80	22/25	25/25	-	-
	C07J	1	1	5.4/7.2	18.42/24.56	26/30	74/79	90/90	33/38	35/40	-	-
	C10J	2	1	7.2/9.6	24.57/32.76	34.7/40	85/91	90/100	44/50	45/50	-	-
	C15J	3	2	10.8/14.4	36.85/49.13	52/60	106/116	110/110	65/75	70/80	-	-
	C20J	4	2	14.4/19.2	49.12/65.52	69.33/80	128/141	150/150	87/100	90/100	-	-
	No Heat	-	-	-	-	-	128/141	150/150	-	-	128/141	150/150

ELECTRIC HEATER KIT - 3 PHASE RQNM

208-240 VOLT, THREE PHASE, 60 HZ, AUXILIARY ELECTRIC HEATER KITS CHARACTERISTICS AND APPLICATION												
Model No. RQNM-	Single Power Supply For Both Unit And Heater Kit						Separate Power Supply For Both Unit And Heater Kit					
	RXQJ-Heater Kit Nominal KW	No. of Elements	No. of Sequence Steps	Rated Heater kW @ 208-240 V	Heater KBTU/Hr @ 208-240 V	Heater Amp. @ 208-240 V	Unit Min. Ckt Ampacity @ 208-240 V	Over Current Protective Device Size Min/Max @ 208 V	Heater Kit Min. Ckt. Ampacity	Heater Kit Max. Fuse Size	Heat Pump Min. Ckt. Ampacity 208-240	Heat Pump Over Current Protective Device Size Min/Max @ 208 V
A036C	No Heat	-	-	-	-	-	17/17	20/25	-	-	17/17	20/25
	C10C	2	1	7.2/9.6	24.57/32.76	20/23.1	42/46	45/45	25/29	25/30	-	-
	C15C	3	2	10.8/14.4	36.85/49.13	30.1/34.7	55/61	60/60	38/44	40/45	-	-
A042C	No Heat	-	-	-	-	-	23/23	30/35	-	-	23/23	30/35
	C10C	2	1	7.2/9.6	24.57/32.76	20/23.1	48/52	50/50	25/29	25/30	-	-
	C15C	3	2	10.8/14.4	36.85/49.13	30.1/34.7	61/66	70/70	38/44	40/45	-	-
	C20C	4	2	14.4/19.2	49.12/65.52	40/46.3	73/81	80/80	50/58	50/60	-	-
A048C	No Heat	-	-	-	-	-	23/23	30/35	-	-	23/23	30/35
	C10C	2	1	7.2/9.6	24.57/32.76	20/23.1	48/52	50/50	25/29	25/30	-	-
	C15C	3	2	10.8/14.4	36.85/49.13	30.1/34.7	60/66	60/60	38/44	40/45	-	-
	C20C	4	2	14.4/19.2	49.12/65.52	40/46.3	73/81	80/80	50/58	50/60	-	-
A060C	No Heat	-	-	-	-	-	31/31	35/45	-	-	31/31	35/45
	C10C	2	1	7.2/9.6	24.57/32.76	20/23.1	56/59	60/60	25/29	25/30	-	-
	C15C	3	2	10.8/14.4	36.85/49.13	30.1/34.7	69/74	70/70	38/44	40/45	-	-
	C20C	4	2	14.4/19.2	49.12/65.52	40/46.3	81/88	90/90	50/58	50/60	-	-

ELECTRIC HEATER KIT - 1 PHASE RQPM

208-240 VOLT, SINGLE PHASE, 60 HZ, AUXILIARY ELECTRIC HEATER KITS CHARACTERISTICS AND APPLICATION														
Model No. RQPM-	Single Power Supply For Both Unit And Heater Kit							Separate Power Supply For Both Unit And Heater Kit						
	RXQJ-Heater Kit Nominal kW	No. of Elements	No. of Sequence Steps	Rated Heater kW @ 208-240 V	Heater KBTU/Hr @ 208-240 V	Heater Amp. @ 208-240 V	Unit Min. Ckt Ampacity @ 208-240 V	Over Current Protective Device Size Min/Max @ 208 V	Heater Kit Min. Ckt. Ampacity	Heater Kit Max. Fuse Size	Heat Pump Min. Ckt. Ampacity 208-240	Heat Pump Over Current Protective Device Size Min/Max @ 208 V		
A024J	No Heat	-	-	-	-	-	23/23	30/35	-	-	23/23	30/35		
	C05J	1	1	3.6/4.8	12.28/16.38	17.33/20	45/48	45/50	22/25	25/25	-	-		
	C07J	1	1	5.4/7.2	18.42/24.56	26/30	55/60	60/60	33/38	35/40	-	-		
	C10J	2	1	7.2/9.6	24.57/32.76	34.7/40	66/73	70/70	44/50	45/50	-	-		
A030J	No Heat	-	-	-	-	-	24/24	30/35	-	-	24/24	30/35		
	C05J	1	1	3.6/4.8	12.28/16.38	17.33/20	45/49	45/50	22/25	25/25	-	-		
	C07J	1	1	5.4/7.2	18.42/24.56	26/30	56/61	60/60	33/38	35/40	-	-		
	C10J	2	1	7.2/9.6	24.57/32.76	34.7/40	67/74	70/70	44/50	45/50	-	-		
	C15J	3	2	10.8/14.4	36.85/49.13	52/60	89/99	90/90	65/75	70/80	-	-		
A036J	No Heat	-	-	-	-	-	27/27	35/40	-	-	27/27	35/40		
	C05J	1	1	3.6/4.8	12.28/16.38	17.33/20	49/52	50/60	22/25	25/25	-	-		
	C07J	1	1	5.4/7.2	18.42/24.56	26/30	59/64	60/60	33/38	35/40	-	-		
	C10J	2	1	7.2/9.6	24.57/32.76	34.7/40	70/77	70/70	44/50	45/50	-	-		
	C20J	4	2	14.4/19.2	49.12/65.52	69.33/80	114/127	125/125	87/100	90/100	-	-		
A042J	No Heat	-	-	-	-	-	36/36	45/50	-	-	36/36	45/50		
	C05J	1	1	3.6/4.8	12.28/16.38	17.33/20	47/61	60/70	22/25	25/25	-	-		
	C07J	1	1	5.4/7.2	18.42/24.56	26/30	68/73	70/80	33/38	35/40	-	-		
	C10J	2	1	7.2/9.6	24.57/32.76	34.7/40	79/86	80/90	44/50	45/50	-	-		
	C20J	4	2	14.4/19.2	49.12/65.52	69.33/80	112/136	125/125	87/100	90/100	-	-		
A048J	No Heat	-	-	-	-	-	36/36	45/50	-	-	36/36	45/50		
	C05J	1	1	3.6/4.8	12.28/16.38	17.33/20	57/61	60/70	22/25	25/25	-	-		
	C07J	1	1	5.4/7.2	18.42/24.56	26/30	68/73	70/80	33/38	35/40	-	-		
	C10J	2	1	7.2/9.6	24.57/32.76	34.7/40	79/86	80/90	44/50	45/50	-	-		
	C20J	4	2	14.4/19.2	49.12/65.52	69.33/80	122/136	125/125	87/100	90/100	-	-		
A060J	No Heat	-	-	-	-	-	43/43	50/60	-	-	43/43	50/60		
	C05J	1	1	3.6/4.8	12.28/16.38	17.33/20	65/68	80/80	22/25	25/25	-	-		
	C07J	1	1	5.4/7.2	18.42/24.56	26/30	75/80	90/90	33/38	35/40	-	-		
	C10J	2	1	7.2/9.6	24.57/32.76	34.7/40	86/93	90/100	44/50	45/50	-	-		
	C20J	4	2	14.4/19.2	49.12/65.52	69.33/80	130/143	150/150	87/100	90/100	-	-		

ELECTRIC HEATER KIT - 3 PHASE RQPM

208-240 VOLT, THREE PHASE, 60 HZ, AUXILIARY ELECTRIC HEATER KITS CHARACTERISTICS AND APPLICATION														
Model No. RQPM-	RXQJ- Heater Kit Nominal kW	No. of Elements	No. of Sequence Steps	Rated Heater kW @ 208-240 V	Heater KBTU/Hr @ 208-240 V	Heater Amp. @ 208 V	Unit Min. Ckt Ampacity @ 208-240 V	Single Power Supply For Both Unit And Heater Kit			Separate Power Supply For Both Unit And Heater Kit			
								Over Current Protective Device Size @ 208 V	Min./Max @ 208 V	Min./Max @ 240 V	Heater Kit Min. Ckt. Ampacity	Heater Kit Max. Fuse Size	Heat Pump Min. Ckt. Ampacity 208/240	Heat Pump Over Current Protective Device Size @ 208 V / Min/Max @ 240 V
A036C	No Heat	-	-	-	-	-	19/19	25/25	25/25	-	-	19/19	25/25	25/25
	C10C	2	1	7.2/9.6	24.57/32.76	20/23.1	44/48	45/45	50/50	25/30	25/29	-	-	-
	C15C	3	2	10.8/14.4	36.85/49.13	30.1/34.7	57/61	60/60	70/70	40/45	38/44	-	-	-
A042C	No Heat	-	-	-	-	-	26/26	30/35	30/35	-	-	26/26	30/35	30/35
	C10C	2	1	7.2/9.6	24.57/32.76	20/23.1	51/55	60/60	60/60	25/30	25/29	-	-	-
	C15C	3	2	10.8/14.4	36.85/49.13	30.1/34.7	64/69	70/70	70/70	40/45	38/44	-	-	-
	C20C	4	2	14.4/19.2	49.12/65.52	40/46.3	76/84	80/80	90/90	50/60	50/58	-	-	-
A048C	No Heat	-	-	-	-	-	26/26	30/35	30/35	-	-	26/26	30/35	30/35
	C10C	2	1	7.2/9.6	24.57/32.76	20/23.1	51/54	60/60	60/60	25/30	25/29	-	-	-
	C15C	3	2	10.8/14.4	36.85/49.13	30.1/34.7	63/69	70/70	70/70	40/45	38/44	-	-	-
	C20C	4	2	14.4/19.2	49.12/65.52	40/46.3	76/83	80/80	90/90	50/60	50/58	-	-	-
A060C	No Heat	-	-	-	-	-	32/32	40/45	40/45	-	-	32/32	40/45	40/45
	C10C	2	1	7.2/9.6	24.57/32.76	20/23.1	57/61	60/60	70/70	25/30	25/29	-	-	-
	C15C	3	2	10.8/14.4	36.85/49.13	30.1/34.7	69/76	70/70	80/80	40/45	38/44	-	-	-
	C20C	4	2	14.4/19.2	49.12/65.52	40/46.3	82/90	90/90	90/90	50/60	50/58	-	-	-

FIGURE 8
WIRING DIAGRAM - RQNM SERIES

SCHEMATIC DIAGRAM

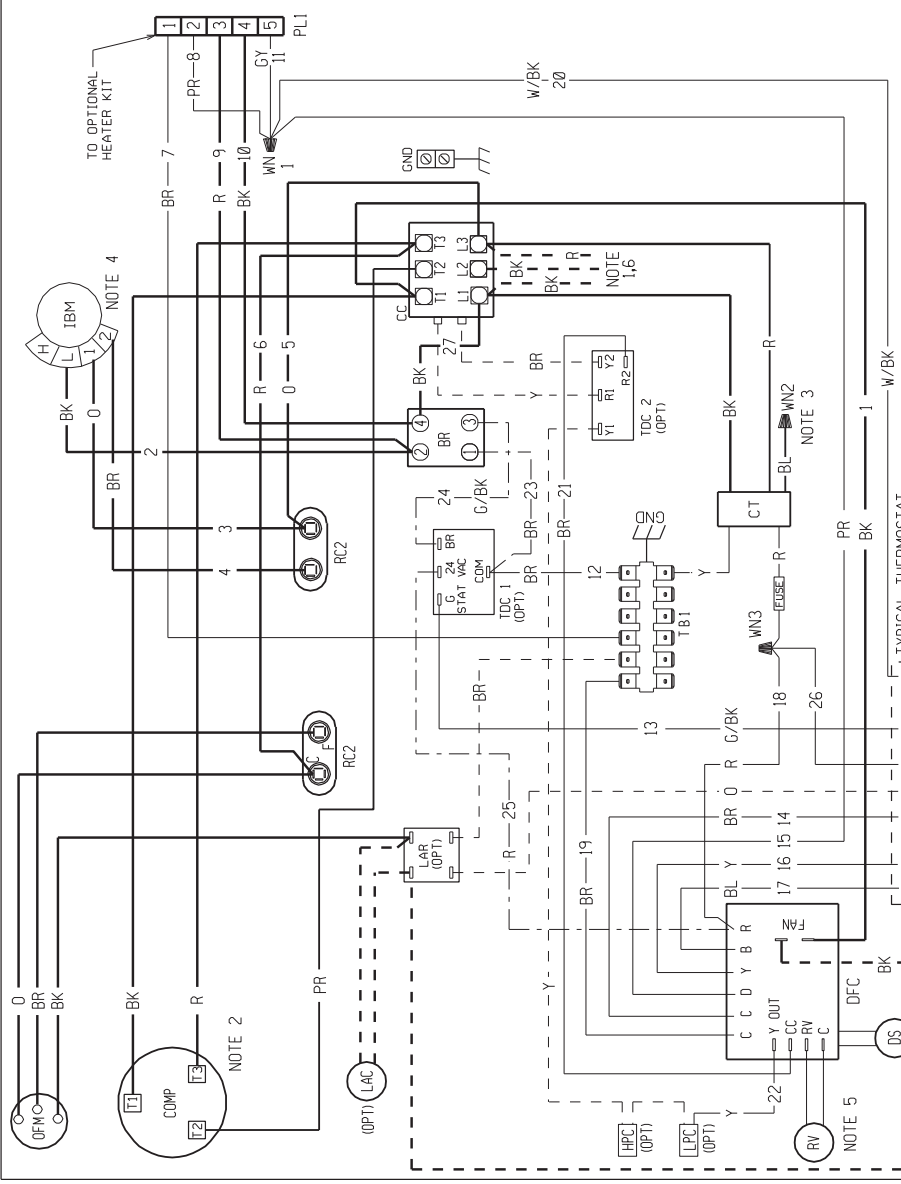
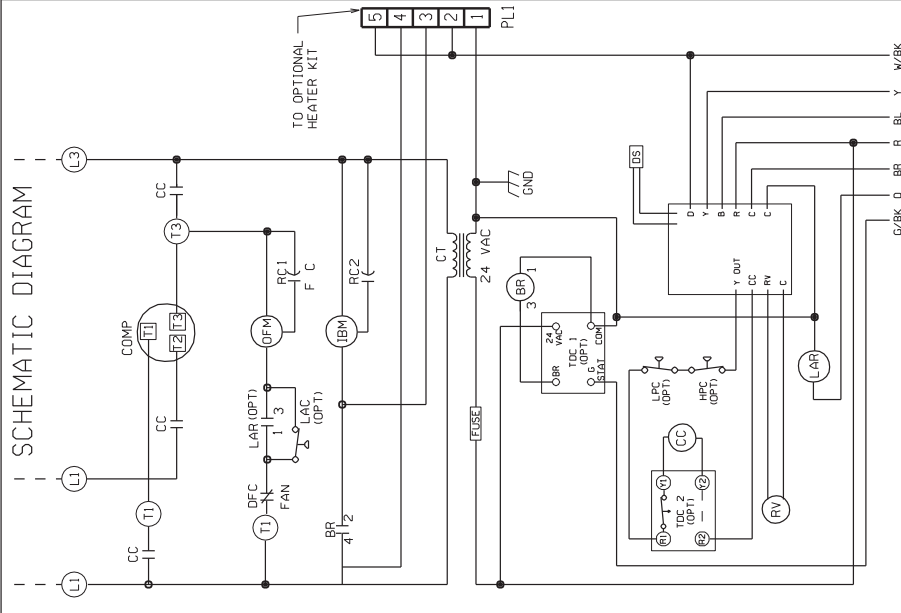

WIRE COLOR CODE

BK	BLACK
OR	ORANGE
BR	BROWN
PR	PURPLE
BL	BLUE
R	RED
W	WHITE
C	GREEN
GY	GRAY
Y	YELLOW

ELECTRICAL WIRING DIAGRAM

PACKAGE HEAT PUMP

3 PH, 208/230 VOLT - 60 HZ

DR. BY DATE 9-29-04
 MCB
 DWG. NO. 90-23621-10
 REV 01

WIRING INFORMATION

- LINE VOLTAGE
- FACTORY STANDARD
- FACTORY OPTION
- FIELD INSTALLED
- LOW VOLTAGE
- FACTORY STANDARD
- FACTORY OPTION
- FIELD INSTALLED
- REPLACEMENT WIRE
- MUST BE THE SAME SIZE AND TYPE OF INSULATION AS ORIGINAL (105 C MIN.)
- CABINET MUST BE PERMANENTLY GROUNDED AND CONFORM TO I.E.C., N.E.C., C.E.C. AND LOCAL CODES AS APPLICABLE.

- NOTES:**
- CONNECTORS SUITABLE FOR USE WITH COPPER CONDUCTORS ONLY.
 - COMPRESSOR MOTOR THERMALLY PROTECTED.
 - TRANSFORMER FACTORY WIRED FOR 230 VOLTS. USE RED AND BLUE LEADS FOR 208 VOLTS.
 - MOTOR FACTORY WIRED FOR LOW SPEED. SEE AIRFLOW TABLES IN INSTALLATION INSTRUCTIONS TO DETERMINE CORRECT SPEED FOR UNIT APPLICATION.
 - THIS COMPONENT ENERGIZED IN HEATING.
 - FIELD WIRING OR CONNECTION FROM HEATER KIT FUSE BLOCK.

COMPONENT CODE

AUX. LIMIT CONTROL	LAC
BLOWER RELAY	LAR
COMPRESSOR CONTACTOR	OFM
CRANKCASE HEATER	OPT
COMPRESSOR	COMP
CONTROL TRANSFORMER	CT
DEFROST RELAY	DFC
DEFROST SENSOR	DS
GROUND	GND
HOT GAS SENSOR	HGS
HIGH PRESSURE CONTROL	HPC
INDOOR BLOWER MOTOR	IBM
LOW AMBIENT COOLING CONTROL	LAC
LOW AMBIENT RELAY	LAR
OUTDOOR FAN MOTOR	OFM
OPTIONAL	OPT
RUN CAPACITOR	RC1
REVERSING VALVE	RV
TERMINAL BLOCK	TB1
TIME DELAY CONTROL	TDC
WIRE NUT	WN3

DWG. NO. 90-23621-10
 REV 01

FIGURE 9
WIRING DIAGRAM - RQPM SERIES

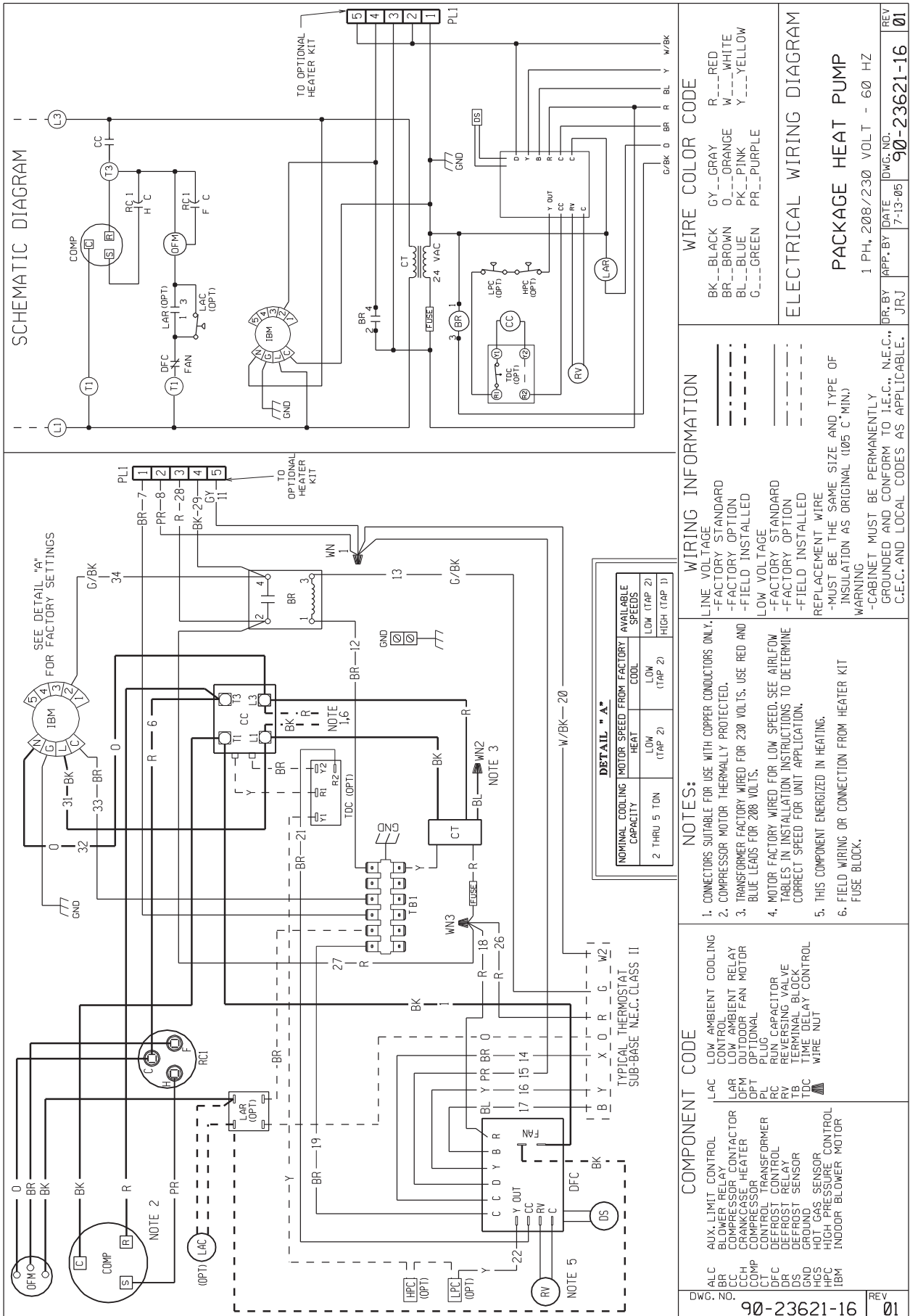

WIRE COLOR CODE

BK	BLACK	GY	GRAY	R	RED
BR	BROWN	O	ORANGE	W	WHITE
BL	BLUE	PK	PINK	Y	YELLOW
G	GREEN	PR	PURPLE		

WIRING INFORMATION

- LINE VOLTAGE
 - FACTORY STANDARD
 - FACTORY OPTION
 - FIELD INSTALLED
- LOW VOLTAGE
 - FACTORY STANDARD
 - FACTORY OPTION
 - FIELD INSTALLED
- REPLACEMENT WIRE
 - MUST BE THE SAME SIZE AND TYPE OF INSULATION AS ORIGINAL (105 C MIN.)
 - CABINET MUST BE PERMANENTLY GROUNDED AND CONFORM TO I.E.C., N.E.C., C.E.C., AND LOCAL CODES AS APPLICABLE.

DETAIL "A"

NOMINAL COOLING CAPACITY	MOTOR SPEED	COOL SPEEDS	AVAILABLE SPEEDS
2 THRU 5 TON	HEAT (TAP 2)	LOW (TAP 2)	LOW (TAP 2)
			HIGH (TAP 1)

NOTES:

- CONNECTORS SUITABLE FOR USE WITH COPPER CONDUCTORS ONLY.
- COMPRESSOR MOTOR THERMALLY PROTECTED.
- TRANSFORMER FACTORY WIRED FOR 230 VOLTS. USE RED AND BLUE LEADS FOR 208 VOLTS.
- MOTOR FACTORY WIRED FOR LOW SPEED. SEE AIRFLOW TABLES IN INSTALLATION INSTRUCTIONS TO DETERMINE CORRECT SPEED FOR UNIT APPLICATION.
- THIS COMPONENT ENERGIZED IN HEATING.
- FIELD WIRING OR CONNECTION FROM HEATER KIT FUSE BLOCK.

COMPONENT CODE

AUX. LIMIT CONTROL	LAC
BLOWER RELAY	LAR
CONTACTOR	CC
CRANKCASE HEATER	OFM
COMPRESSOR	COMP
CONTROL TRANSFORMER	CT
CONTROL RELAY	RL
DEFROST RELAY	RV
DEFROST SENSOR	TB
GROUND	TDC
HOT GAS SENSOR	DS
HIGH PRESSURE CONTROL	HPC
INDOOR BLOWER MOTOR	IBM

WIRING INFORMATION

1. CONNECTORS SUITABLE FOR USE WITH COPPER CONDUCTORS ONLY.
 2. COMPRESSOR MOTOR THERMALLY PROTECTED.
 3. TRANSFORMER FACTORY WIRED FOR 230 VOLTS. USE RED AND BLUE LEADS FOR 208 VOLTS.
 4. MOTOR FACTORY WIRED FOR LOW SPEED. SEE AIRFLOW TABLES IN INSTALLATION INSTRUCTIONS TO DETERMINE CORRECT SPEED FOR UNIT APPLICATION.
 5. THIS COMPONENT ENERGIZED IN HEATING.
 6. FIELD WIRING OR CONNECTION FROM HEATER KIT FUSE BLOCK.

DR. BY APP. BY DATE DWG. NO. REV
 JRJ 7-13-05 90-23621-16 01

90-23621-16 REV 01

FIGURE 11
CHARGING CHART

2.0 TON HP (R410A)

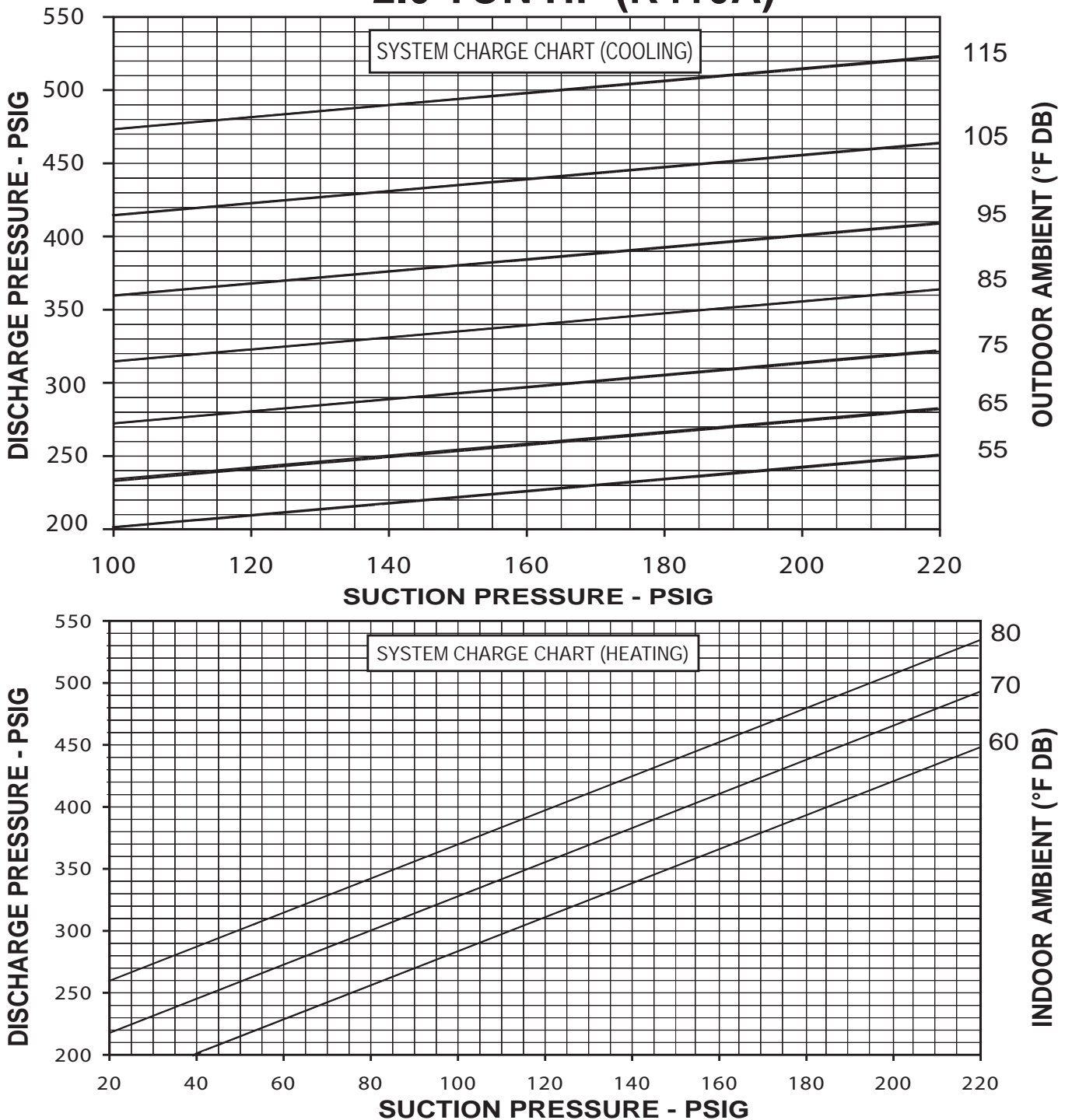

CAUTION: BEFORE FINAL REFRIGERANT CHECK, INDOOR RETURN AIR TEMPERATURE MUST BE BETWEEN 72°F & 76°F DB AT 50% R.H. (HEATING AND COOLING), AND NO ICE ON OUTDOOR COILS (HEATING).

INSTRUCTIONS:

1. CONNECT PRESSURE GAUGES TO SUCTION AND DISCHARGE PORTS ON UNIT.
2. MEASURE AIR TEMPERATURE TO: (a) OUTDOOR COIL FOR COOLING, (b) INDOOR COIL FOR HEATING.
3. PLACE AN "X" ON THE APPROPRIATE CHART WHERE THE SUCTION AND DISCHARGE PRESSURES CROSS.
4. IF "X" IS BELOW AMBIENT TEMPERATURE LINE, ADD CHARGE AND REPEAT STEP 3.
5. IF "X" IS ABOVE AMBIENT TEMPERATURE LINE, RECOVER EXCESS CHARGE AND REPEAT STEP 3.

92-102273-01-01

FIGURE 12
CHARGING CHART

2.5 TON HP (R410A)

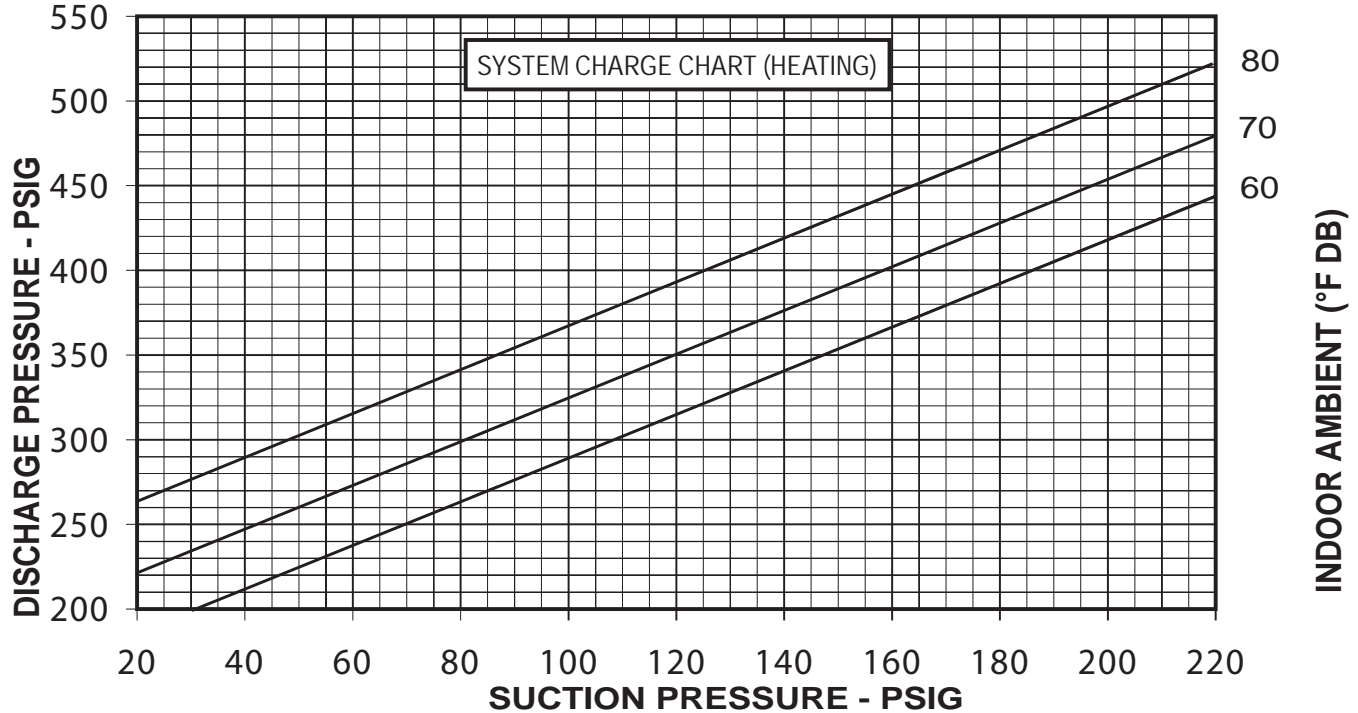
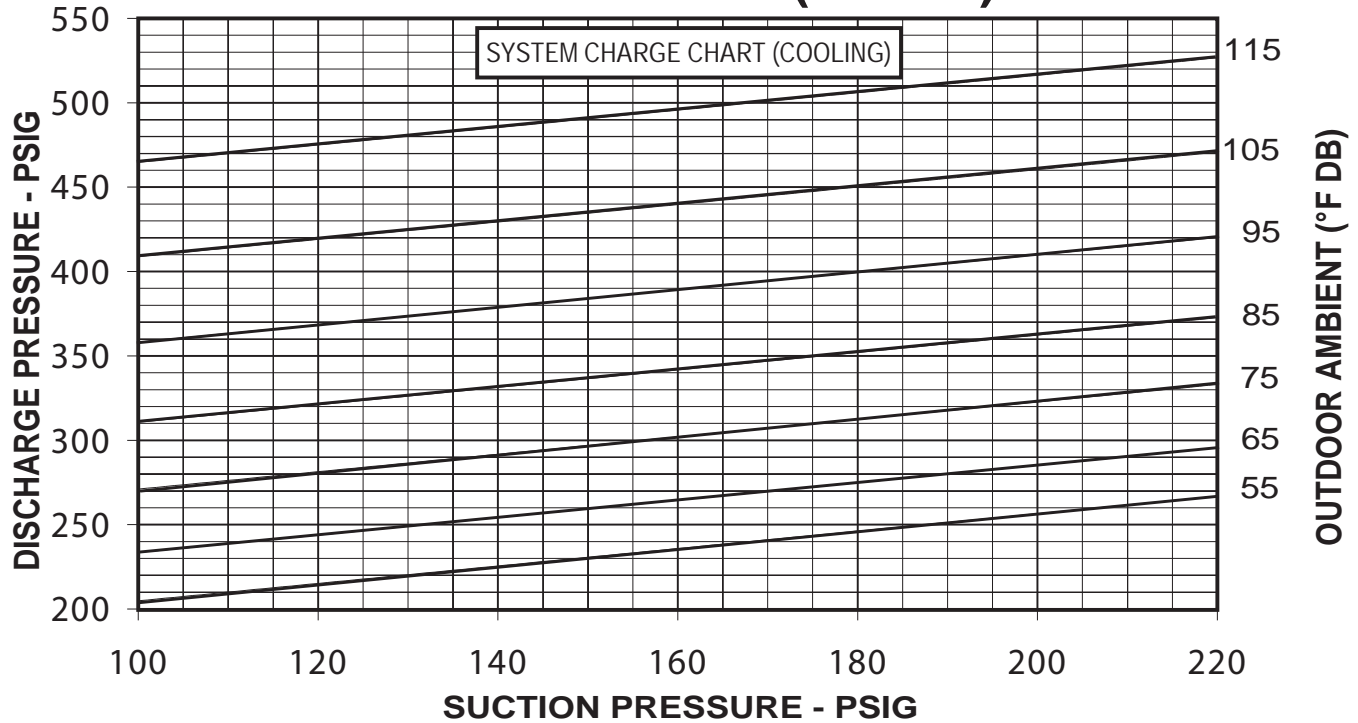

CAUTION: BEFORE FINAL REFRIGERANT CHECK, INDOOR RETURN AIR TEMPERATURE MUST BE BETWEEN 72°F & 76°F DB AT 50% R.H. (HEATING AND COOLING), AND NO ICE ON OUTDOOR COILS (HEATING).

INSTRUCTIONS:

1. CONNECT PRESSURE GAUGES TO SUCTION AND DISCHARGE PORTS ON UNIT.
2. MEASURE AIR TEMPERATURE TO: (a) OUTDOOR COIL FOR COOLING, (b) INDOOR COIL FOR HEATING.
3. PLACE AN "X" ON THE APPROPRIATE CHART WHERE THE SUCTION AND DISCHARGE PRESSURES CROSS.
4. IF "X" IS BELOW AMBIENT TEMPERATURE LINE, ADD CHARGE AND REPEAT STEP 3.
5. IF "X" IS ABOVE AMBIENT TEMPERATURE LINE, RECOVER EXCESS CHARGE AND REPEAT STEP 3. 92-102273-02-01

FIGURE 13
CHARGING CHART

3.0 TON HP (R410A)

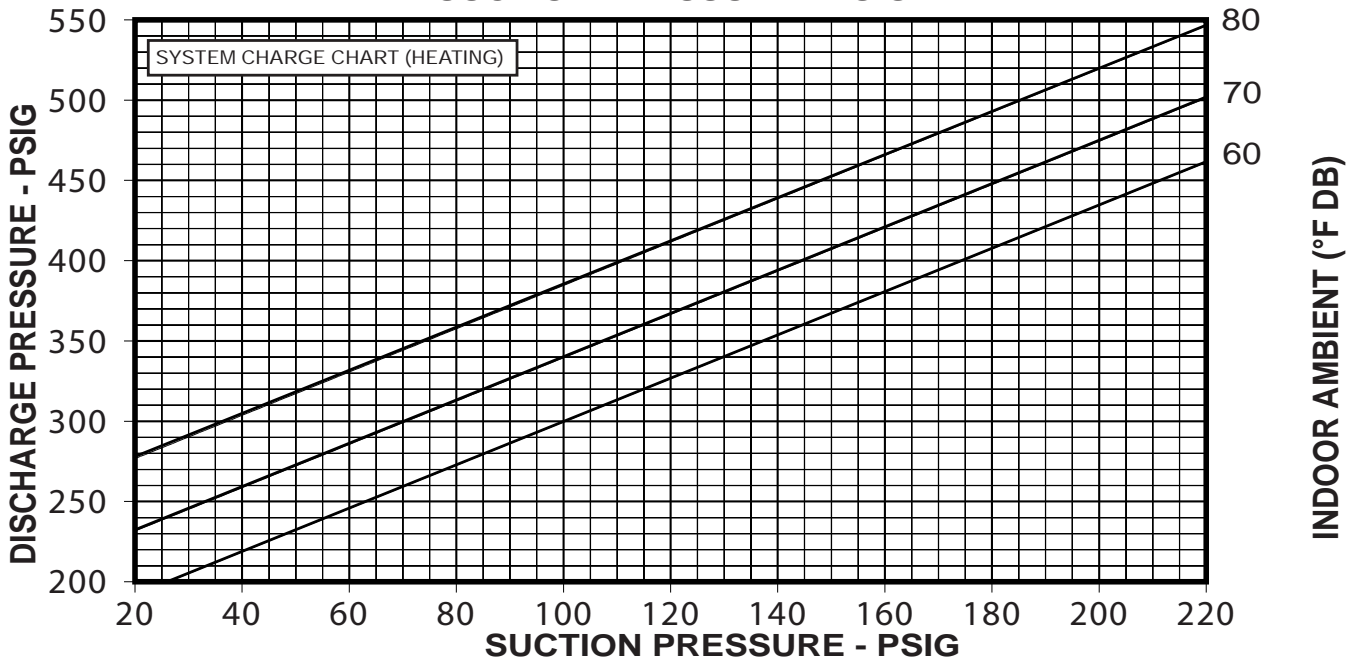
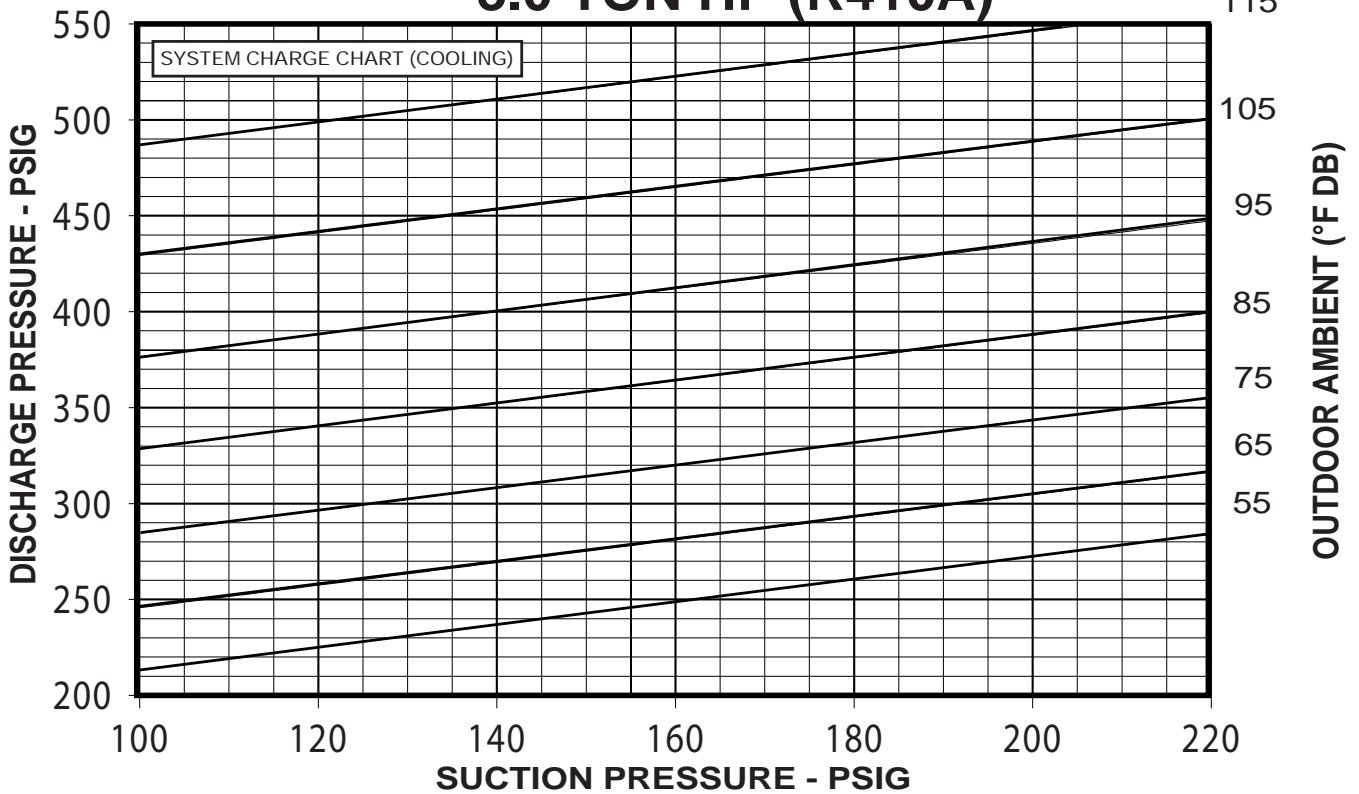

CAUTION: BEFORE FINAL REFRIGERANT CHECK, INDOOR RETURN AIR TEMPERATURE MUST BE BETWEEN 72°F & 76°F DB AT 50% R.H. (HEATING AND COOLING), AND NO ICE ON OUTDOOR COILS (HEATING).

INSTRUCTIONS:

1. CONNECT PRESSURE GAUGES TO SUCTION AND DISCHARGE PORTS ON UNIT.
2. MEASURE AIR TEMPERATURE TO: (a) OUTDOOR COIL FOR COOLING, (b) INDOOR COIL FOR HEATING.
3. PLACE AN "X" ON THE APPROPRIATE CHART WHERE THE SUCTION AND DISCHARGE PRESSURES CROSS.
4. IF "X" IS BELOW AMBIENT TEMPERATURE LINE, ADD CHARGE AND REPEAT STEP 3.
5. IF "X" IS ABOVE AMBIENT TEMPERATURE LINE, RECOVER EXCESS CHARGE AND REPEAT STEP 3. 92-102273-03-01

FIGURE 14
CHARGING CHART

3.5 TON HP (R410A)

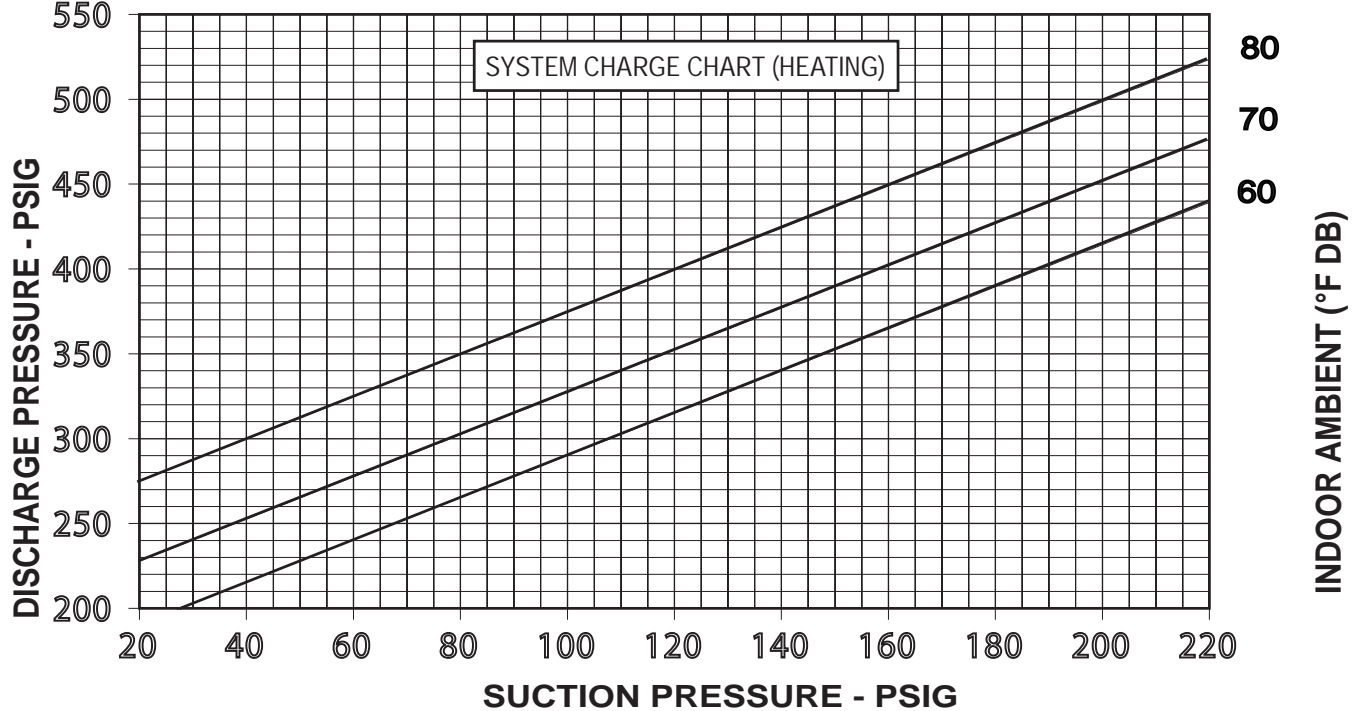
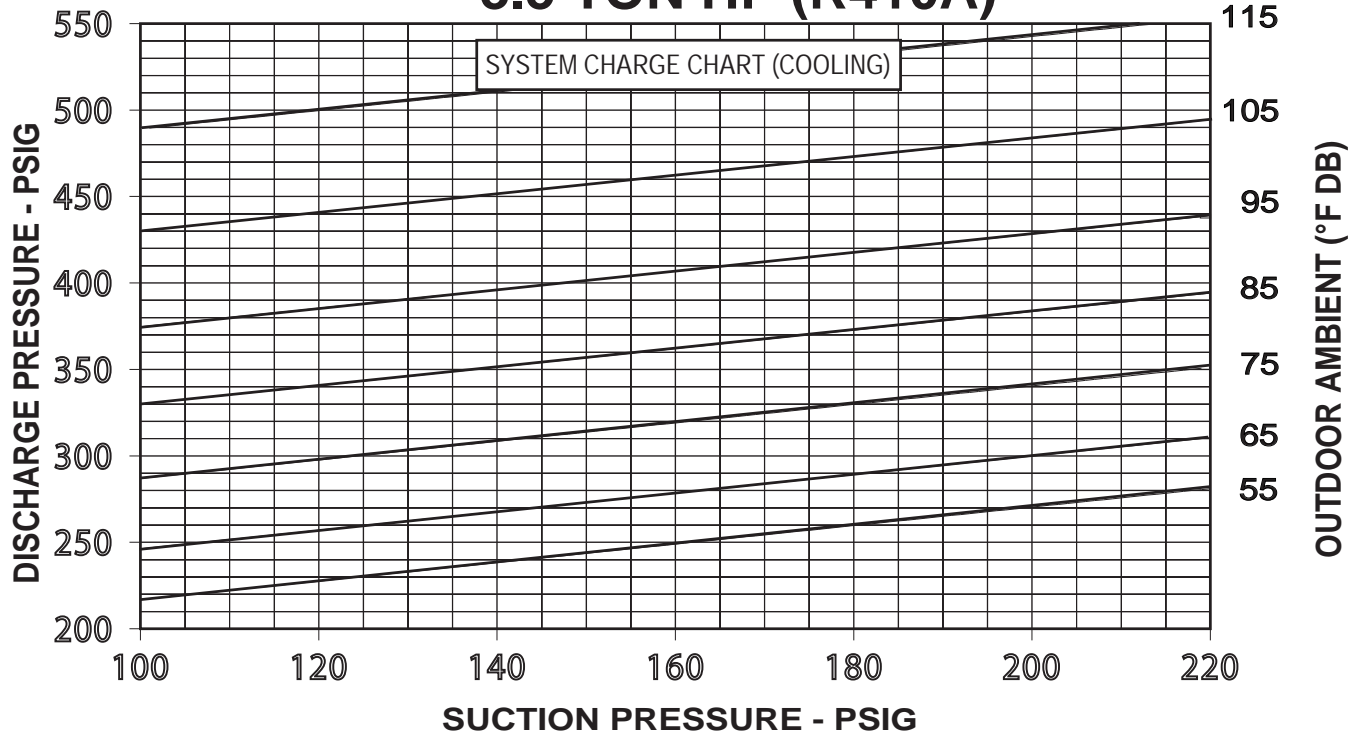

CAUTION: BEFORE FINAL REFRIGERANT CHECK, INDOOR RETURN AIR TEMPERATURE MUST BE BETWEEN 72°F & 76°F DB AT 50% R.H. (HEATING AND COOLING), AND NO ICE ON OUTDOOR COILS (HEATING).

INSTRUCTIONS:

1. CONNECT PRESSURE GAUGES TO SUCTION AND DISCHARGE PORTS ON UNIT.
2. MEASURE AIR TEMPERATURE TO: (a) OUTDOOR COIL FOR COOLING, (b) INDOOR COIL FOR HEATING.
3. PLACE AN "X" ON THE APPROPRIATE CHART WHERE THE SUCTION AND DISCHARGE PRESSURES CROSS.
4. IF "X" IS BELOW AMBIENT TEMPERATURE LINE, ADD CHARGE AND REPEAT STEP 3.
5. IF "X" IS ABOVE AMBIENT TEMPERATURE LINE, RECOVER EXCESS CHARGE AND REPEAT STEP 3. 92-102273-04-01

FIGURE 15
CHARGING CHART

4.0 TON HP (R410A)

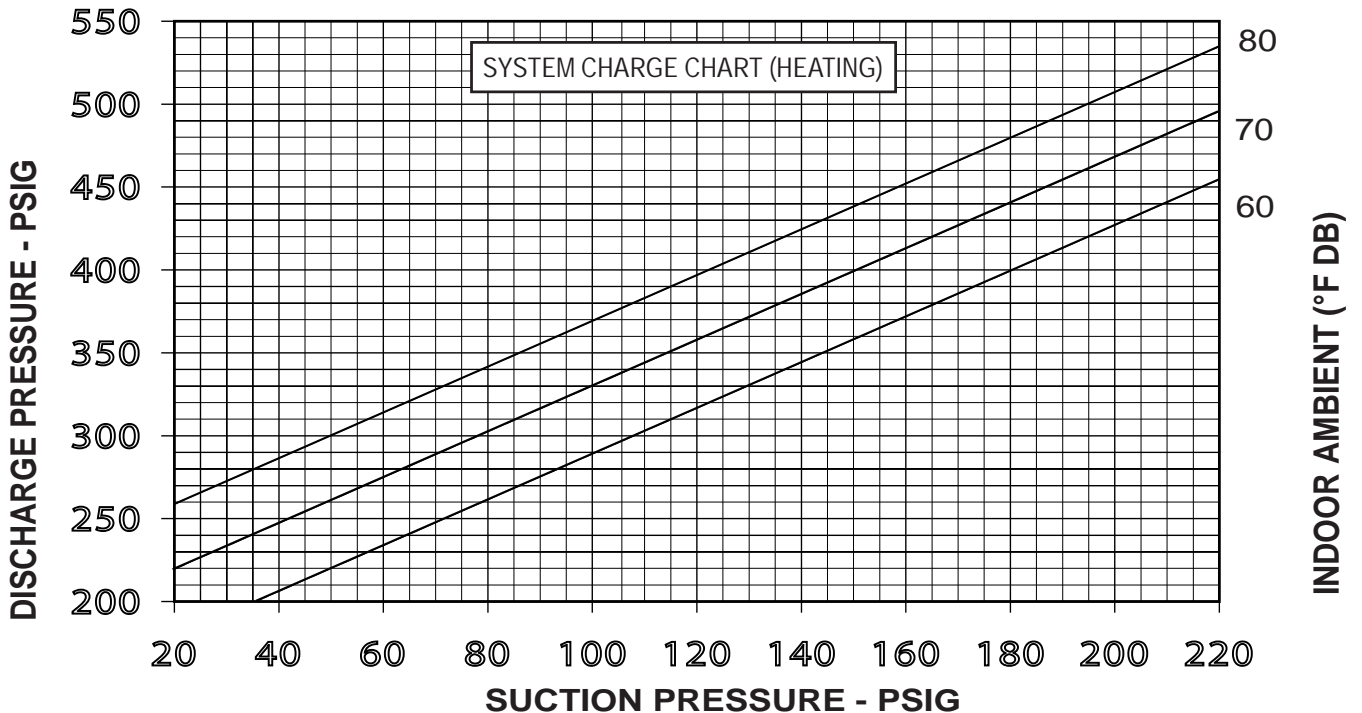
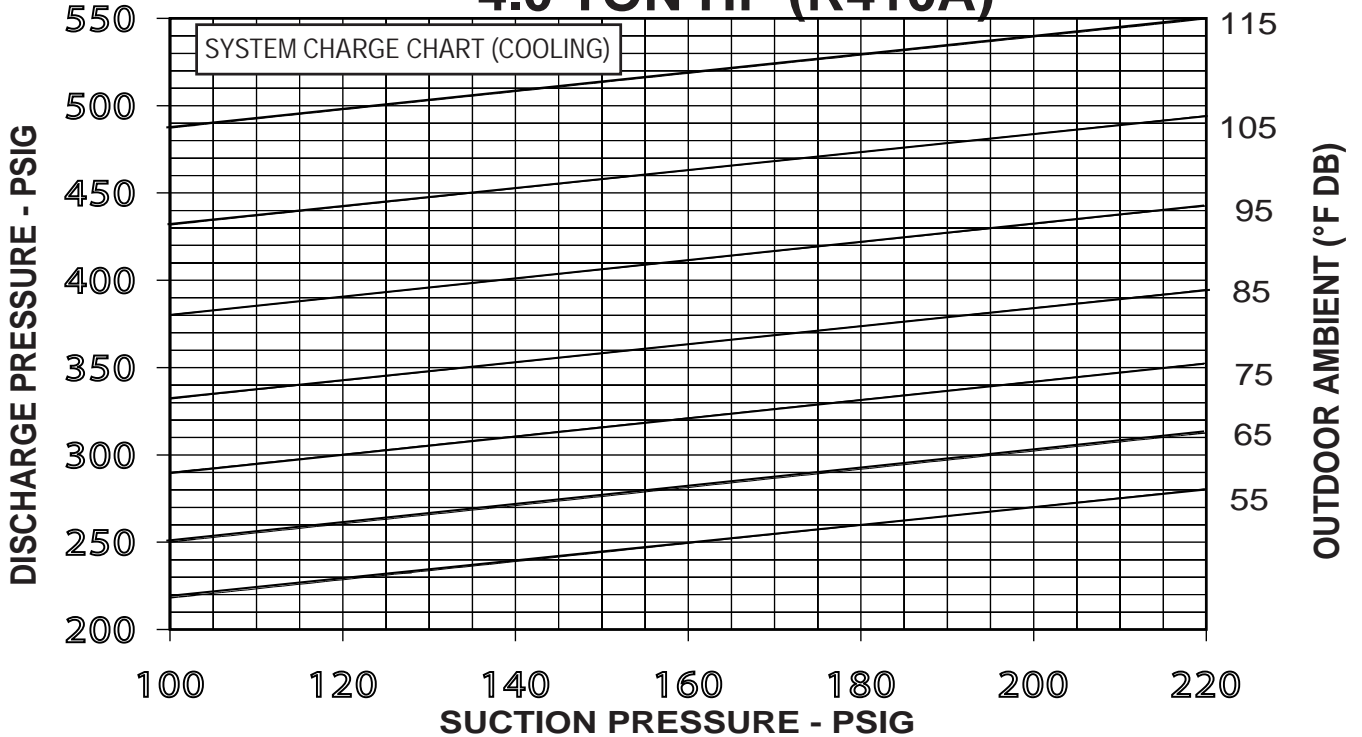

CAUTION: BEFORE FINAL REFRIGERANT CHECK, INDOOR RETURN AIR TEMPERATURE MUST BE BETWEEN 72°F & 76°F DB AT 50% R.H. (HEATING AND COOLING), AND NO ICE ON OUTDOOR COILS (HEATING).

INSTRUCTIONS:

1. CONNECT PRESSURE GAUGES TO SUCTION AND DISCHARGE PORTS ON UNIT.
2. MEASURE AIR TEMPERATURE TO: (a) OUTDOOR COIL FOR COOLING, (b) INDOOR COIL FOR HEATING.
3. PLACE AN "X" ON THE APPROPRIATE CHART WHERE THE SUCTION AND DISCHARGE PRESSURES CROSS.
4. IF "X" IS BELOW AMBIENT TEMPERATURE LINE, ADD CHARGE AND REPEAT STEP 3.
5. IF "X" IS ABOVE AMBIENT TEMPERATURE LINE, RECOVER EXCESS CHARGE AND REPEAT STEP 3. 92-102273-05-01

FIGURE 16
CHARGING CHART

5.0 TON HP (R410A)

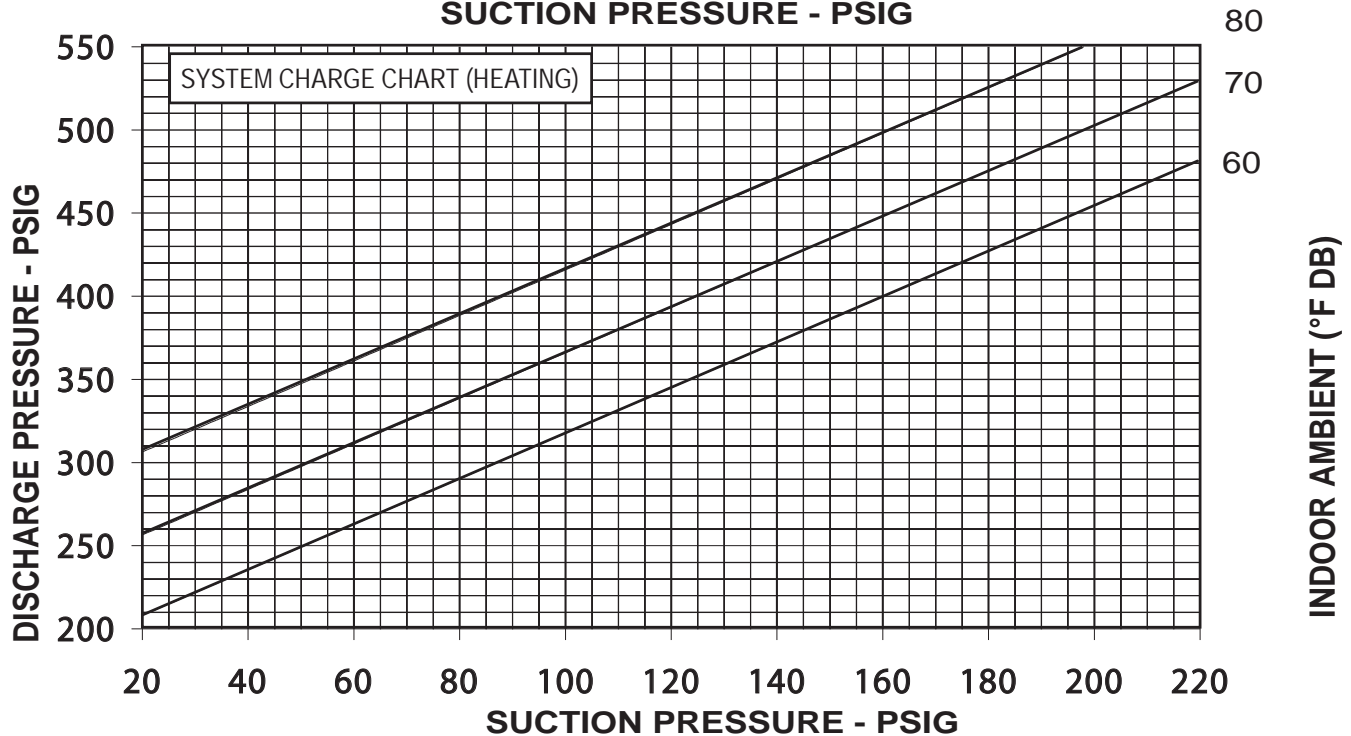
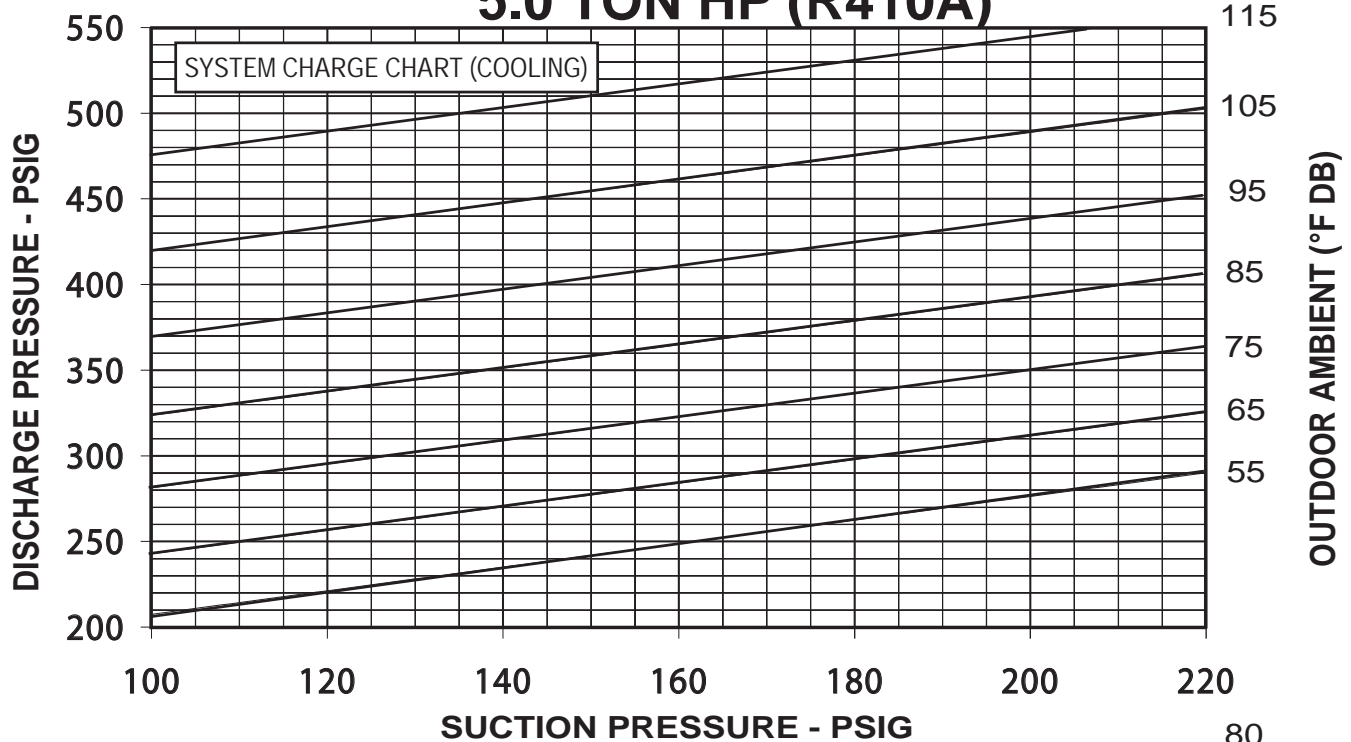

CAUTION: BEFORE FINAL REFRIGERANT CHECK, INDOOR RETURN AIR TEMPERATURE MUST BE BETWEEN 72°F & 76°F DB AT 50% R.H. (HEATING AND COOLING), AND NO ICE ON OUTDOOR COILS (HEATING).

INSTRUCTIONS:

1. CONNECT PRESSURE GAUGES TO SUCTION AND DISCHARGE PORTS ON UNIT.
2. MEASURE AIR TEMPERATURE TO: (a) OUTDOOR COIL FOR COOLING, (b) INDOOR COIL FOR HEATING.
3. PLACE AN "X" ON THE APPROPRIATE CHART WHERE THE SUCTION AND DISCHARGE PRESSURES CROSS.
4. IF "X" IS BELOW AMBIENT TEMPERATURE LINE, ADD CHARGE AND REPEAT STEP 3.
5. IF "X" IS ABOVE AMBIENT TEMPERATURE LINE, RECOVER EXCESS CHARGE AND REPEAT STEP 3. 92-102273-06-01